

Perfectly Finished Web Printed Products

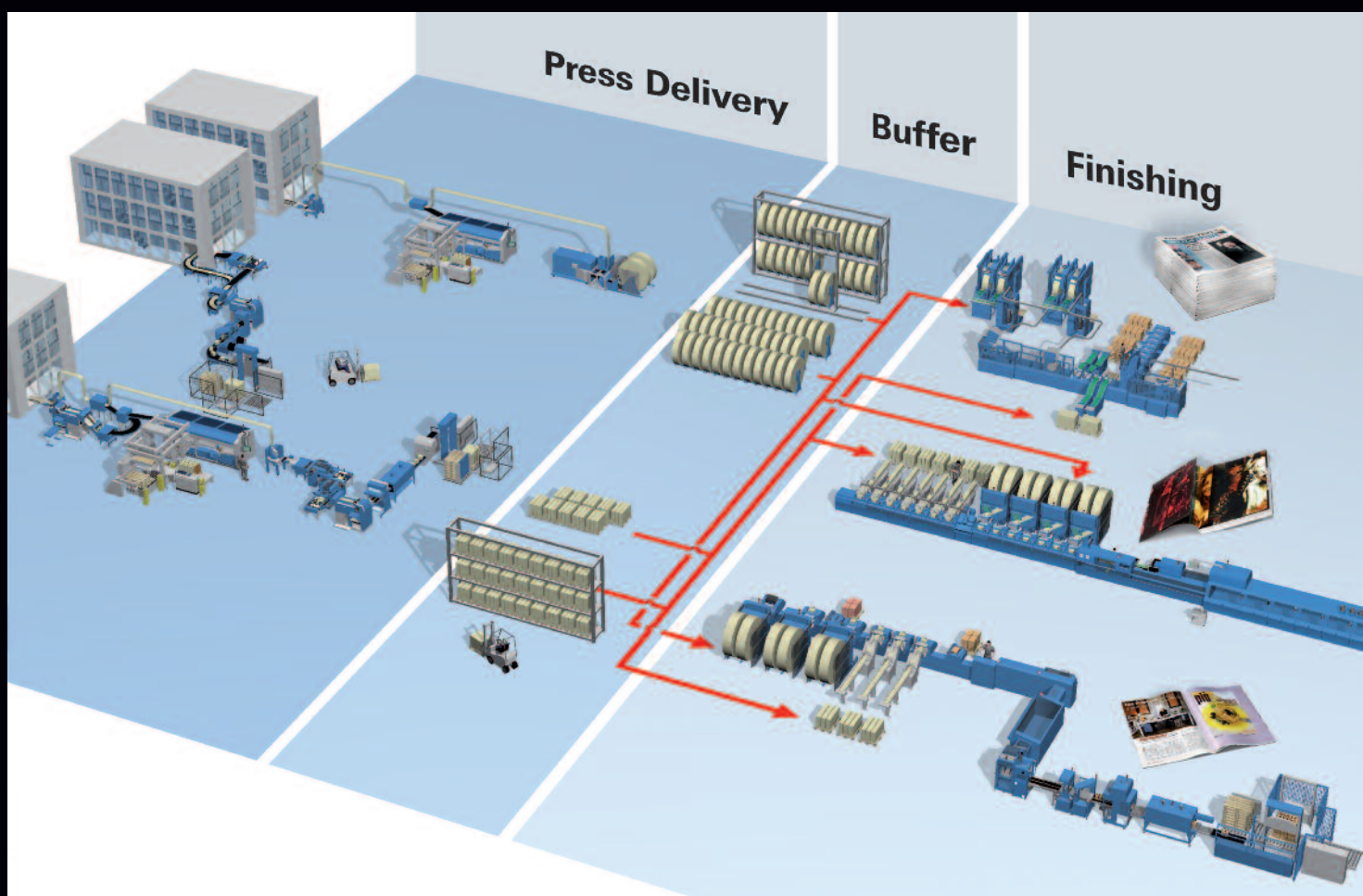



Perfectly Finished Web Printed Products

Best practice guide for web offset printers

**Aylesford Newsprint, Kodak, Trelleborg, manroland,
MEGTEC, Müller Martini, Nitto, Quad/Tech, SCA, SunChemical
In association with Eltex and Timsons**

The content and value of this publication have been vastly helped by the assistance of individuals, printers and associations who gave their time and expertise to review and improve this guide.

Principal contributors:

Aylesford Newsprint, *Mike Pankhurst*; Eltex, *Lukas Hahne*; Kodak GCG, *David Elvin*; Trelleborg, *Marc Than*; manroland, *Max Schable*; MEGTEC Systems, *Colin Morris*, *Eytan Benhamou*; Müller Martini Print Finishing Systems, *Felix Stirnimann*; Nitto, *Bart Ballet*; QuadTech, *Randall Freeman*; Timsons, *Jeff Ward*; SCA, *Marcus Edbom*; Sun Chemical, *Gerry Schmidt*, *Paul Casey*.

Other contributors:

Eurografica, Germany; *Thomas Schonbucher*, *David Cannon*; Planatol, *Frank Huer*; QuadGraphics, *Patrick Douglas-Meis*; Tolerans, *Charlotte Banning*; Welsh Centre for Printing and Coating, Swansea University, *Tim Claypole*

Besonderer Dank gilt der PIA und der WAN-IFRA für ihre Unterstützung und die Erlaubnis zum Abdruck einiger Materialien.

Herausgeber und Koordinator *Nigel Wells*

Illustrationen: *Anne Sophie Lanquetin* with permission of FICG and ECOConseil.

Abbildungen von *Alain Fiol*

Design und Druckvorstufen von *Cécile Haure-Placé und Jean-Louis Nolet*

Fotos: Aylesford Newsprint, Hunkeler, Kodak GCG, manroland, MEGTEC, Muller Martini, Quad Graphics QuadTech, Sun Chemical, Technotrans.

© Web Offset Champion Group, 2011. All rights reserved. ISBN N° 978-2-915679-22-9
Der Leitfaden ist in Englisch, Französisch, Deutsch, Italienisch und Spanisch erhältlich.
Bestelladresse für Nordamerika: PIA printing@printing.org
In allen anderen Regionen wenden Sie sich bitte an den nächsten Partner der Web Offset Champion Group - weboffsetchampions.com

Bibliography & sources of information

"Binding, Finishing and Mailing: The Final Word" 2nd Ed., T. J. Tedesco, Dave Clossey, Jean-Marie Hershey, Printing Industries of America, 2005

Introduction

The printed product is the result of a creative design and production process. Finishing is its final stage and cannot be considered in isolation; rather, it is a critical element in an integrated business process. When things go wrong at the finishing stage, often it is because the bindery is so far removed from the design and specification process that meaningful communication has not taken place. The purpose of this guide is to improve results through better communication and understanding amongst all participants in the workflow — designers, print users, publishers, printers and binders, and their suppliers.

Finishing operations can be either inline with printing or through the use of dedicated offline postpress systems. Finishing applies not only to magazines, books, reports and catalogues but also to newspapers and their products. There is now an increasing convergence between these formerly separate print products and processes.

The two most significant factors that determine quality between printed products are the finishing method and the paper used. Finishing is the final assembly of a product that is a three-dimensional object which can be almost infinitely variable — it incites the job to be “touched”, at which point the paper adds “feel” to its perception. No other media can communicate with these senses. Advances in technology and consumable materials offer a growing range of finishing options to provide value added printed products quickly and cost effectively.

The quality of a print product is not dependent on a single process step — prepress, print process, press delivery and storage system affect the quality of finishing. Sustained quality and the ideal price/performance ratio can be achieved only through continuous and effective communication and collaboration across the process chain.

With the introduction of high levels of automation and process control, postpress hardware and software have undergone a significant revolution. CIP-4 with JDF (Job Definition Format) now integrates postpress equipment with that of prepress and press to enable presetting and automatic data transfer, significantly improving productivity and transparency of operations. A side benefit of automation is a reduction of work related injuries and accidents.

IMPORTANT SAFETY NOTE !

Always check a machine is in its specified safe position before working on any component (e.g. with compressed air, electrical power and gas disconnected). Only trained maintenance personnel adhering to safety regulations should perform maintenance work. A general guide cannot take into account the specificity of all products and procedures. We therefore strongly recommend that this guide be used in addition to information from your suppliers, whose safety, operating and maintenance procedures take precedence.

This guide is produced for printers worldwide. However, there are some regional variations of terminology, materials and operating procedures.

1: The end product

The end product & selection of finishing 4

Improving finishing productivity & quality 6

Common problems of finished products 7

2: Printing process issues to optimise finished products

Paper selection, prepress & ink 8

Drying and conditioning 9

Remoistening 10

Inline gluing, fold softening & stitching 11

Folder requirements 12

Sheeted cover printing & coating 14

3: Postpress processing

Press delivery systems

Print finishing in the press delivery system 16

Print rolls 17

Logs 18

Inline trimming 20

Stack production 22

Palletising 23

Preventing transit marking 25

Saddle stitching

Operation 26

Three-knife trimmer 28

Spine cracking 29

Perfect adhesive binding

Operation, adhesives & tests 30

Binding systems 34

To assist readers we have used a number of symbols to bring attention to key points:



Best practice



Poor practice



Potential cost reduction



Safety risk



Quality issue

The end product

Specifications and workflow planning begins with the finished job. Working backwards from the end product's qualities and intended functions, the most appropriate technical and materials specifications are defined. These should include the type of paper, reproduction standards, proofs, and measurement and finishing specifications.

The visual appearance, finishing and materials of a print job are influenced by:

- Purpose/use of the printed job to the target reader and advertiser
- Dimensions when finished, number of pages
- Production turnaround time
- Probable product life
- Distribution method
- Economics

These considerations help determine the design, the type of print product, its binding, cover and paper quality, which all have an impact on production costs. Economic and time constraints will also have significant impact on finishing choice — inline or offline, saddle stitching or perfect binding. The perfectly finished product requires effective collaboration between the paper supplier, printer, bookbinder, publisher and designer.

Inline finishing

Many retail catalogues, some magazines and newspapers are bound by gluing or stapling in the press folder and then rotary trimmed to deliver a fully finished product ready for delivery while eliminating costs for offline stitching, intermediate transportation and storage.



Typical saddle stitching printing products.

Photo: Muller Martini

Eyelet staples have a U-shape bulge to allow multipage products to be clamped together; these are referred to as eyelet staples or loop stitches. Special stitching heads are required for this. Two or four staples correctly spaced along the spine of a brochure allow the product to be placed in a file. Photo Muller Martini



	Inline gluing	Inline stitching
Thickness of bound product	8-144 pages	8-192 pages
Applies fold softening	Yes	No
Binding sensitive to paper coating / ink coverage	Yes	No
Binding in web direction	Yes	No
Binding across web direction	Yes*	Yes
Production speed limitations	None	None
Recycling of bound products	OK	OK
Product lays flat for good post press handling	Yes	Yes
Clean-up time	Moderate	Rapid

*Needs a special cross web gluing system

The increased use of tabloid and Berliner formats has increased newspaper inline binding applications to both add value and comply with distribution requirements in Europe that require free newspapers to be bound to make them easier to recover for recycling. Stitching or gluing can create distinct sections in multi-sectioned tabloid newspapers. Some formats are more suitable to stitch and others to glue, e.g. stitching is more economic for tabloid products, particularly if several sections are bound at the same time; and a collect product can only be stitched. Inline gluing systems are particularly useful to reduce fold cracking problems by applying fold softening. Glue consumable costs increase with length of product to be glued.

Offline finishing — saddle stitched or perfect bound?

The choice between these two binding techniques is determined by a combination of the desired product characteristics that includes their perceived aesthetics and production characteristics of speed and cost.

Saddle stitching: Technically one of the simplest binding methods. The signatures are opened, gathered and stitched together with wire through the spine and then trimmed on three sides. Production features rapid makeready with a production speed three times faster than perfect binding. The process is simple (it has no milling, gluing and drying sections), cheaper than perfect binding with lower investment costs, and requires less floor space.

Typical applications include magazines, brochures, leaflets, consumer catalogues, CD booklets, manuals, and instruction booklets. Efficient production of these applications requires saddle stitching systems to be adapted to the type of print job.

Product characteristics	Saddle Stitching	Perfect Binding
Thickness range of bound product	1-19 mm	3-80 mm
Single-sheet processing	No	Yes
Thin signatures – up to 4 pages	Yes	More difficult
Openability & lay flat opening	Excellent	More limited
Spine printing	No	Yes
Double cover	Yes	No
Single and double gatefold covers	Yes	Yes
Gatefold text sections	Yes	Yes
Samples, stick-on notes and cards	Yes	Yes
Thick or small books tend to spring open	Yes	No
Production characteristics		
Inline 2-up or 3-up production (without layout change)	Yes	More difficult
Process	Simple	More complex
Makeready	Very fast	Slower
Production speed	40 000 c/h	Slower 18 000 c/h
Investment cost	Lower	Higher
Space required	Compact	More space needed



Inkjet imprinting systems integrate easily with web offset presses and web finishing equipment to allow printers to leverage their existing assets by adding value to direct marketing and other jobs and extend their business opportunities. Photo: Kodak

Perfect adhesive binding: The individual signatures of a product are bound using a spine adhesive; advantages include increased flexibility and topicality of the products from single sheet processing, higher product quality and better aesthetics.

The binding is durable (dependent on glue) and provides a high level of single sheet binding strength even for heavy duty use. It allows processing of signatures and single sheets with bound thicknesses from 2 mm to 80 mm (0,08-3,15”). The layflat behaviour is good, but less than saddle stitching, and it is possible to print along the book spine. Its principal disadvantage is that it is a slower and more expensive process in comparison to saddle stitching.



Typical perfect bound products include paperback books, telephone directories, magazines, catalogues, brochures and operating manuals. Photo: Muller Martini

Value added binding products

An increasing emphasis for both saddle stitching and perfect binding is in the production of value added products within the finishing operation. This can include single and double gatefold covers or text, inserts, onserts, glued-on samples, stick-on notes and cards, plus addressing, personalisation and film wrapping in one operation.





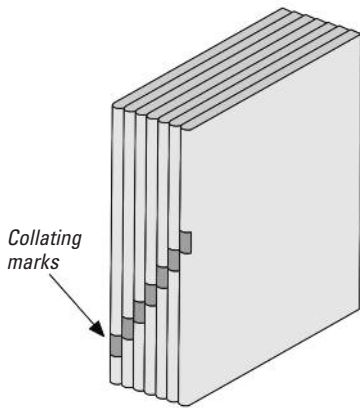







Improving finishing productivity & quality



Section collating marks.

Waste in the bindery is expensive because the costs of a defect are at their highest in an almost finished job.

Many factors can impact on the finished product quality, including incompatible types of binding and/or certain production characteristics (ink type and film weight, paper and drying) or incorrect job preparation. Only a view of production as an interrelated system from job specification to delivery can optimise productivity and waste.

-  **Preflight finishing:** Simple correct procedures can help prevent disasters. *See page 6.*
-  **Define optimal overs:** Not all jobs are the same and waste allowances for postpress should be related to the job's characteristics — paper type and weight, size, signature type, etc. Waste optimisation teams can substantially reduce the overall bindery waste on most jobs while avoiding the risk of short quantity.
-  **Folder:** Improved postpress productivity begins at the folder exit. Check the silicone applicator on the press for signatures that are susceptible to static or are too slippery. Perforating the closed head or foot of the signature in the folder allows the paper to stretch, avoids wrinkles, and improves the signature density.
-  **Quality of logs:** Correctly stored printed signatures can improve saddle stitching and perfect binding productivity by 25-30%. Damaged bundles and signatures significantly reduce the productivity of a bookbinding system. Sub-standard bundles due to a poor shingle stream feed must be dealt with at the folder. *See page 16.*
-  **Signature delivery problems:** Many cannot be rectified by just changing the settings in the delivery system and frequently require upstream process issues to be addressed at the folder.
-  **Blocking:** It may not be possible to rectify this with stacker settings. Actions may be needed at prepress, or at the dryer. Sometimes lowering the press speed may provide a quick fix.
-  **Correct packaging:** Avoid transit marking/damage, which is the most expensive waste. *See page 23.*
-  **Product tracking and counting:** An important aspect of waste reduction is to print exactly the predetermined number of signatures. This requires accurate product tracking in the press delivery system. Most conveyors have around 1,000 signatures in transit from the folder exit that, if incorrectly counted, are a repetitive source of avoidable waste. Copy count tracking systems should include the conveyor and use encoders to track the shingle stream with increased accuracy. This also allows waste from splice and blanket wash to be diverted more accurately, further reducing total waste. A back-up solution on the press delivery system can help reduce press down time. For example, if a rotary trimming line has a jam, the shingle stream is automatically diverted into a second stacker or a print roll. These buffered signatures can be re-fed into the trimming line at the end of the print run.
-  **Productivity maintenance:** Reliable production requires good maintenance, clean surroundings, dust free sensors, etc. Implement effective maintenance programmes to reduce waste and improve reliability and net production speeds. *See WOCG Guide N° 4.*
-  **Makeready unsetting:** According to *"Binding, Finishing & Mailing"* the starting condition of postpress equipment is identified as a key factor on makeready speed. In regard to unsetting machines (Return to Original Condition) the following applies:
 1. If the last job off a machine is similar to the next one being set up, and the machine has not been 'unset', then makeready for next job should be extremely fast.
 2. If the last job off a machine is very different to the next one being set up, and the machine has not been 'unset', then makeready for next job will be slow.
 3. If the machine has been unset, then the speed of makeready should be standard.Which of these scenarios to use is determined by the order and profile of the jobs to be run. Unsetting machines is recommended when trim size, paper thickness, and page count for the next job are different from the job currently being run. The advantages of routinely unsetting machines are that there are fewer 'lost' parts, better maintenance, and more consistent running. Unsetting machines also requires less skilled staff than makeready and this should be considered as part of the total economic cost to see if it is viable. Automated changeover also minimises makeready.
-  **Automation:** Streamfeeder automated loading for saddle stitching and perfect binding lines reduces labour and minimises bindery waste to increase efficiency. Signature recognition systems improve production reliability.

Some common problems of finished products

Problem	Premedia/Prepress origin
Incorrect trimming	Pages out of position that can lead to image being trimmed off. Insufficient bleed allowances — especially on covers when spine width adjustments required. Bleeds on final fold line rather than trim line Insufficient margins. Image on first and last pages of perfect bound books in hinge scoring/gluing area. Colour bars too close to image area. Miscalculated spine thickness for perfect bound books — covers.
Misalignment	Misalignment of bleed indexes.
Missing data marks	Centre, register, trim, folding, collating, etc.
Risk of stitches pull through	Risk on weak papers with high ink coverage — use UGR, UCA . Leave image-free zone at spine.
Printing, folding & delivery origin	
Spine cracking	Too high dryer temperature, use spine softening or gluing
Marking	Wet ink and uncoated sheets with heavy ink cover Offsetting from transit marking
Incorrect trimming	Web fold misregistration Out of register: Cut-Off movement in web direction from tension variations; and/or web wander. Folds not perforated Inaccurate trim (inline)
Risk of stitches pull through	Paper cracking at spine that leads to stitches being pulled through the weak spine.
Brittle paper after drying	Incorrect dryer profile / No remoistening
Blocking of signatures	Incorrect dryer profile / Heavy ink coverage
Feeder interruptions	Poor quality logs / Signature curl / Unevenly pressed signatures / Incorrect handling
Waste in good copies	Roll change waste inadvertently goes into production
Incorrect quantity	Counting inaccuracy
Growing text	Growth of heatset printed text outside of the sheetfed printed cover.
Static in winter	Add anti static or fabric softener to silicone solution.
Poor lamination	Excessive spray powder on covers to be laminated
Storage/Transit damage	Ink not sufficiently dry Covers not adequately protected (coated, laminated, slip sheets)
Saddle stitching origin	
Signatures sticking together	Static electricity from very dry air in production/higher incidence of static electricity in winter High level of humidity
Risk of stitches pull through	Ensure that stitching heads produce a clear cut and the staple legs are not overly bent
Incorrect paper flow direction	Incorrect paper flow direction in single-sheet cover
Incorrect sequence	Incorrectly compiled (sequence of signatures)
Incorrect product make-up	Incorrect product make-up (languages, for example), signatures look identical in every language
Missing items	e.g. CD, reply cards, inserts, etc
Incorrect stitching	Poor wire quality, residues after flexing, wire spool is empty
Storage/Transit damage	Incorrect packing (box size, palletizing, shrink wrapping, electrostatic)
Perfect binding origin	
Inadequate adhesion of pages	Inks can break down the hotmelt adhesive (displacement of softening agent)
Gaps in the glue application	Excessive moisture in paper or cover
Poor opening	Scoring on covers with UV coating and inadequate elasticity in coating being pried open
Cover pops off	Ink or coating inhibits glue adhesion
Transit or storage origin	
Storage/Transit damage	Excessive temperature or humidity (plant, storage, transit, destination) or inadequate packing

* The risk of stitches pull through is for offline stitching only, not inline.

Many of these problems can be spotted during preflighting.

Print process issues to optimise finishing

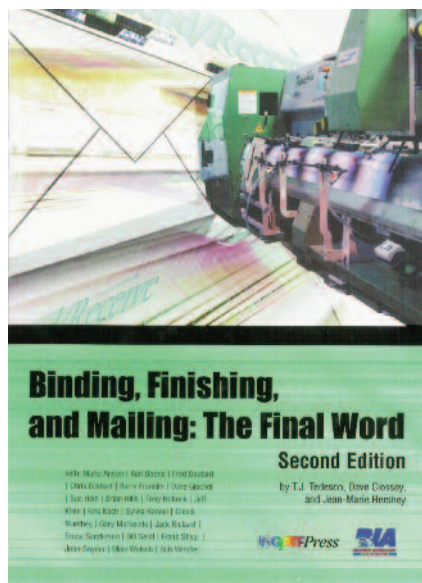

“Binding, Finishing & Mailing: The Final Word” published by Printing Industries of America, 2005 is an excellent postpress reference.

Preflighting postpress

Preflighting is the verification of digital file quality to ensure that they are correct and complete before they leave the design agency and/or as they enter the printer’s prepress operations (*“Binding, Finishing & Mailing”*). This principle should also apply to finishing to ensure that all pertinent postpress issues are verified and to identify any layout mistakes. The goal is to prevent avoidable errors that can reduce productivity or quality of the finished job. The preflight result should be 1, OK to go ahead with production; 2, adjust job to correct errors; or 3, return the job to designer to correct.

Critical elements include:

- Presence of relevant postpress data marks for centre, register, trim, folding, collating (depending on the finishing process to be used)
 - Sheetfed elements require additional marks for side lay and gripper edge to ensure bindery register
 - Other essential information can be included in the trim-off areas to identify versions, languages, etc.
- A folded and bound dummy using the production paper should also be reviewed prior to production, or an unbound folding dummy or proof with pages in position provided (make sure rotation of folds are marked so that it can be correctly re-folded).

Ideally every job for the bindery should come with a ruled-up press sheet drawn from the marks that show trim, final size, perforations, scoring, folding, etc. This will allow the bindery to identify any production issues and assist presetting to reduce makeready time.

Selection of paper to purpose

Paper and finishing are usually the key factors that differentiate quality between printed products. Publishers, advertisers, printers and print buyers generally select paper based on the combination of cost and suitability for use including:

- Desired paper and print quality
- Bindery or special finishing (higher bulk = higher paper stiffness for efficient processing) (for perfect binding see page 28)
- End product suitability to target reader
- End product lifecycle (newspaper, advertising catalogue, magazine, book)
- Environmental aspects (recycling, bleaching, harvesting, etc.)
- Distribution method: postal (weight = cost), insertion into a publication.

Managing ink coverage at prepress

Applying these techniques helps stabilise the printing process, improve printing quality by reducing overinking and associated drying and marking issues. It will also reduce ink consumption. The lower level of inking leads to faster makeready with less waste and better drying properties.

GCR (Grey Component Replacement): Black replaces process colour ink that has a greying effect and can be applied to any portion of the reproduction. GCR is distinct from UCA, which reduces process colours in dark neutral areas. It is also important to use UCA to add colour under black ink to maintain gloss and density. Ifra recommends GCR and not UCR (Under Colour Removal) for newspaper reproduction.

UCA (Under Colour Addition): Addition of chromatic colours to ensure acceptable density and gloss in shadow areas. When combined with GCR and UCR, UCA ensures acceptable densities and gloss of black solids to minimise overinking, drying and blocking problems.

Attention to local ink variations

Different countries and regions use different inks. For example, Germany and Japan tend to have stronger inks with more pigment. Standards such as ISO/PSO compliant inks need to be strong in pigment. Current ISO standard ink coverage is too high for many papers. Note that for newsprint printed heatset there is currently no ISO standard.

Lower cost inks replace expensive pigments with varnishes and as a consequence are weaker; this tends to increase coverage (e.g. TAC 320) to compensate for lack of pigment, which can lead to runability and quality issues.

Drying and conditioning

The dryer, chill rolls and web conditioning play a critical role in the quality and productivity of saddle stitched and perfect bound web offset products. It is critical that the dryer and chill systems operate to the correct specifications and drying profile for the paper concerned. See WOCG BPG 3 pages 26-27.

Blocking

“Blocking” occurs where signatures in a log stick together and impede postpress operations. The cause(s) can be analysed from production data from the dryer and chill system. Blocking is rarely the result of a single cause but is usually a combination of several factors:

- Blocking can sometimes be traced to poor chilling (insufficient water flow, or water too warm, or insufficient web-to-chill contact), too high temperatures in dryer or conditioning zone. Solvent condensate on the chills is a highly probable cause of blocking.
- Excessive ink density can also cause blocking as this slows down solvent evaporation due to the increasing difficulty in getting solvent vapour to travel through solids as they compact. The thicker the ink film, the longer it takes to dry. See also WOCG BPG 3, pages 20 and 23.
- Dampening solution volume is related to ink density. Water is only second in mass to paper for drying energy consumption and any excess can create problems. Removing water from the web cools the paper by evaporative cooling; it is important not to overly dry out the paper. Water does not only come from the dampening system, but also from the paper and the pressroom. If paper is cold, it will attract humidity and absorb it once exposed to a warmer environment. Cold chill rolls have a similar behaviour except they cannot absorb the water. Handling and storage are also potential contributors to rolls with too much moisture.
- If problems persist testing of inks for thermal stability may be needed to ensure that the inks act as a “set” and have a “window” of temperature where they are all “dry”.
- A reduced exhaust flow may be a factor in blocking, but the cause and effect is not clear.
- Finishing specialists recommend a maximum ink coverage of 240/320 % to prevent blocking.

Silicone application

A silicone layer on the paper helps to protect the surface, gives it additional gloss, and helps smooth the surface to facilitate the folded signature transport in the delivery stream. Ink and silicone emulsion must be matched because there is a risk that the silicone emulsion can dissolve the ink, which is also a risk if the drying process is too hot.

 Some printers set their silicone transfer rollers to rotate against the web running direction usually when running INP / SC papers. While this leads to increased silicone transfer, it increases the risk of marking in the folder, stripes on the printed image, misting, web breaks and smearing of the ink.

 It is recommended to rotate the silicone transfer rollers in the web running direction and to use an emulsion with a higher concentration to minimise misting.

 Wax additives in silicone can reduce marking on heavy papers, but these signatures cannot then be UV coated.

 Additives can significantly help with marking problems on matt coated and silk finished papers.

 Too much silicone can increase the risk for web breaks at mill joins on highly absorbent papers like Newsprint and Improved Newsprint. The join scrapes off a high volume of silicone that weakens the paper. If the mill join breaks straight along the tape after the print units it is probably caused by the silicone.

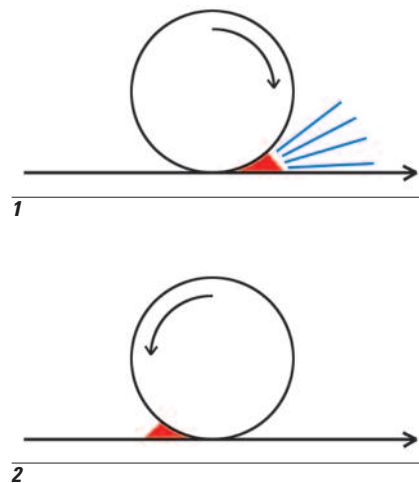

1- Silicone roller rotation against web running direction is not recommended because of risk of misting and other problems.

2- Silicone roller rotation in web running direction is recommended. Apply a higher silicone concentration if needed.

Remoistening

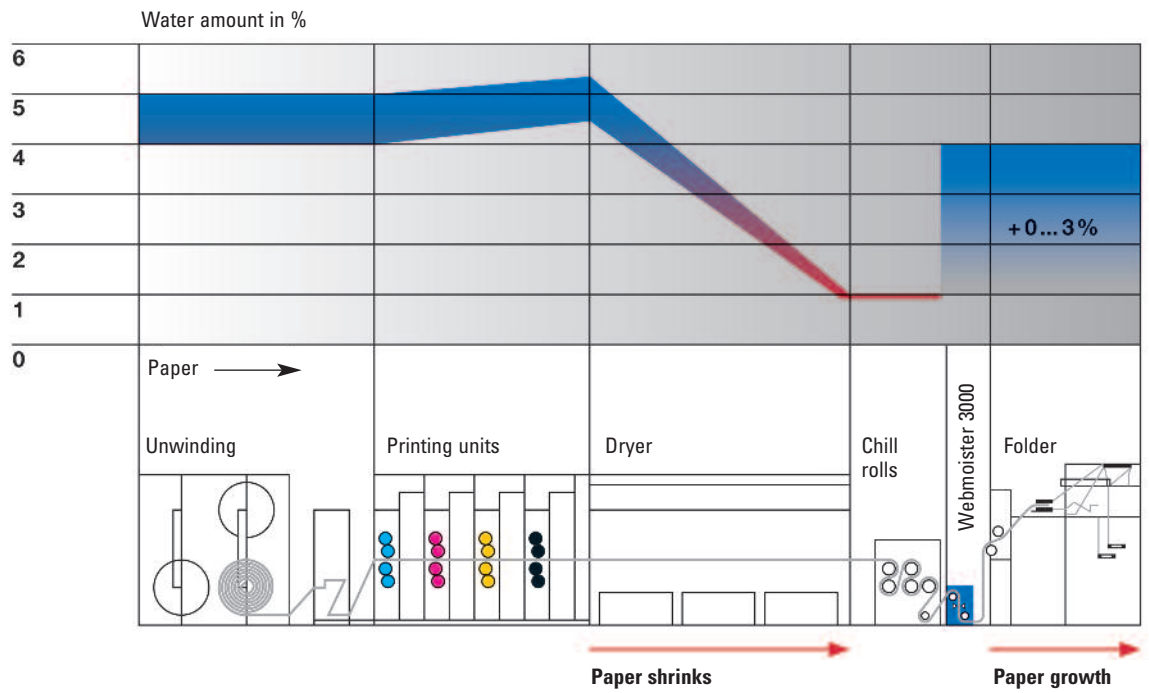

1



Paper needs sufficient moisture to be in equilibrium with its ambient environment. Unprinted heatset web offset paper has a water content of 4-5% which drops to between 0.5 and 2.5%, after drying — depending on the dryer temperature.

The application of silicone solution remoistens the paper to some extent. This effect is limited if the applicator is placed after the folder superstructure because the web is too cool to absorb much water in a short time. A silicone applicator after the dryer and before the chill stand has a better remoistening effect, as the hot web is still open at that stage.

Remoistening systems

2



Some presses have dedicated remoistening units that force moisture under the closed web surface after the chill stand. This system uses an electric charge to put the desired amount of humidity into the web. The unit is best placed between the chill stand and silicone applicator. As a rule of thumb, after this type of remoistening the paper should regain around 80% of its initial value. The benefits include:

- Eliminates buckling of perfect bound cross-grain products
- No growing of page dimensions from mixed production (sheetfed and web offset)
- Prevents fibre breakage
- Prevents climate waves, but does not prevent tension waves
- More even shingle stream with more reliable production and fewer counting errors
- Easier handling from a more stable compensated stack
- Increased postpress productivity from reduction of static related problems
- Reduced silicone consumption with less build-up and a better optical print product
- Better running properties in the folder and more exact folds
- Reduce web breaks and less dust formation in the folder to reduce cleaning.

3

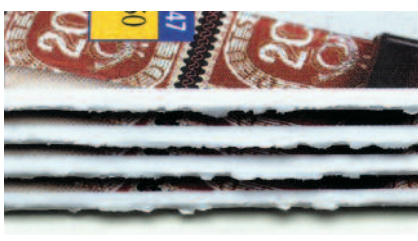

1- Water content in the paper during the printing process.

2- Remoistening eliminates buckling of perfect bound short grain products.

3- Remoistening prevents page dimensions growing in mixed production.

4- Remoistening stops fibre breaking.

Source: Eltex

4

Inline gluing, fold softening, & stitching

Inline glued products have a completely flat fold that provides good handling in stacking, palletising, print finishing and inserting. Brochures, magazines, and newspapers can be spine glued to provide a product of high quality that is easy to handle. Inline fold gluing can be used on all web offset paper qualities.

Longitudinal gluing with intermittent contact and fold softening application runs at up to 20 m/sec. Up to 80 applicator heads can be controlled for longitudinal gluing and fold softening. Short grain A3, A4 and A5 products can only be glued inline with a dedicated cross-web gluer. Gluing systems are now fully integrated with the press control console and allow presetting of parameters like glue pattern or head positions.

Inline gluing systems can reduce fold cracking and pull through of saddle stitched centre pages by applying fold softening to remoisten the paper along the spine.

Different types of glue are used for newsprint and coated papers. Paper coating acts as a barrier to the adhesive's penetration to the paper fibre and requires a specific glue type. High ink coverage can also limit glue adhesion and it is recommended to leave an ink free zone for the glue to optimise adhesion. The adhesive's standby capacity without drying-up of the applicator nozzles also needs to be considered, therefore regular flushing of the gluing system is recommended.

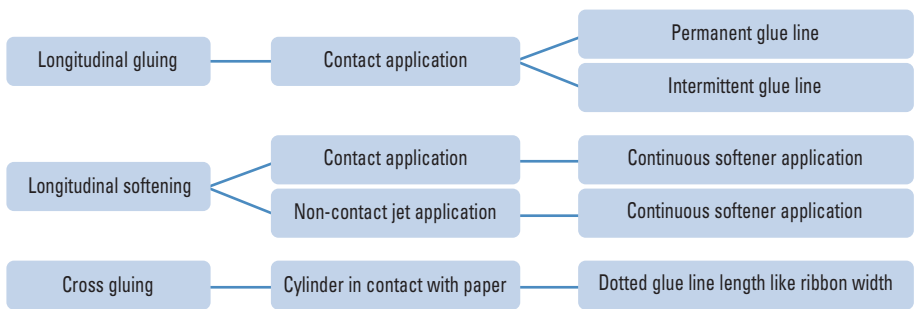

Application possibilities. Source: Planatol

Inline stitching

Stitching inline is made cross web and suitable for tabloid, mini-Berliner or A4 sized products for any web width. Stitching of 8-192 pages is possible at full production speed and does not interfere with the printing process. One or several sections can be stitched in one print run, either straight, or inserted in a broadsheet or tabloid newspaper.

Inline stitching is a growing trend all over the world. The two staples provide design flexibility for double page spread images and headlines.

Two types of inline stitching machines are available, ribbon stitchers that are placed under the former board (or anywhere there is a ribbon passage in the press), and cylinder stitchers that stitch against the folding cylinder in the press. The slimmest ribbon stitcher is only 100 mm (3,94") high.

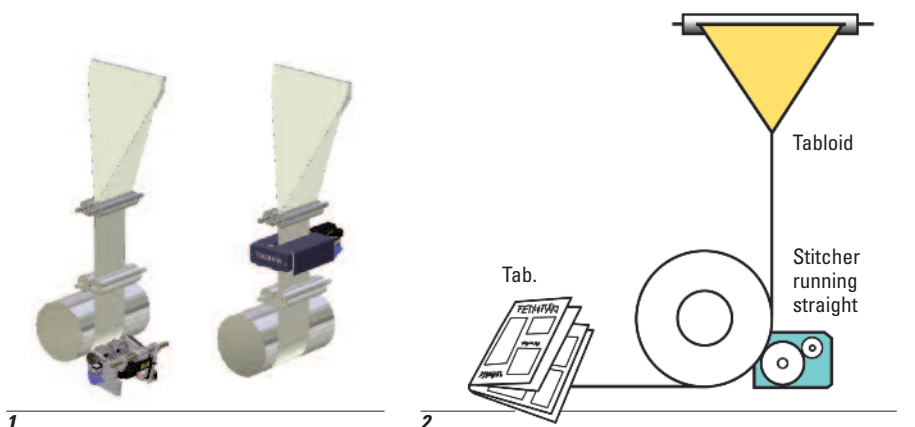

1 2

Application

The applicator heads can be run with or without contact to the paper.

- The contact method provides a straight and well-defined glue line.
- A non-print area of about 2 mm wide should be left where the glue trace is planned, particularly for coated papers.
- Using the non-contact application method may cause glue fogging and badly formed glue lines.
- Best gluing results require applicator heads to be at an angle around 2° off the horizontal position relative to the web.

Store adhesives in a cool (>5°C/41°F) but frost-free area in the closed original container, and out of direct sunlight. Agitate the glue after long storage. Close container after use. Use water mixed with fold softening concentrate for cleaning.

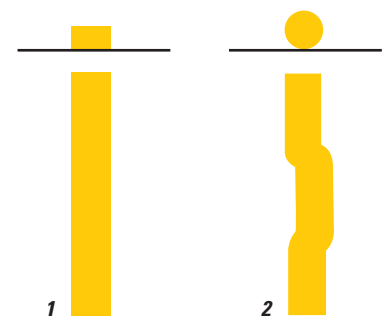

1- Contact application glue line profile.
2- Non-contact jet application glue line profile. Source: Planatol

1- Left: Cylinder stitcher Right: Ribbon stitcher. Depending on the folder configuration, applications can be possible either for double- or single-width presses, and with single or double round stitchers. Source: Tolerans

2- Cylinder stitching of one product in straight or collect mode. Suitable to produce one section and run in either straight or collect mode for higher pagination. Source: Tolerans

Folding Process

Adjustments during print run	Quality issues to avoid						
	Creases	Dog ears	Measurements	Skew folds	Spine cracking	Initial tearing	Shingle quality
Former position	●	●	●				
Circumferential register for cross perforation	●		●	●	●		
Lateral register for longitudinal perforation	●		●	●	●		
Overlap 1st cross fold			●				
Overlap 2nd cross fold			●				
Slow down mechanism quarter fold				●		●	
Quarter fold table position				●			
Timing tucker blade quarter fold		●		●		●	
Magnetic, or brush brake, of quarter fold				●		●	
Circumferential adjustment for delivery fan							●
Adjustable stepping wheel							●

The quality and productivity of finishing is significantly influenced by the quality of the printed signature at the folder delivery. The principal quality criteria are:

- Measurements: cut register and folding spine tolerance
- Form: skew folds, dog ears
- Surface: gussets, wrinkles
- Print: marking, smearing
- Paper condition: cracking at spine, initial tearing, tears, snippets
- Offline finishing: quality of shingles – distance and angle

Factors influencing folding quality: Folder performance and quality depends on the combination of multiple process parameters and production possibilities such as:

- Paper: weight and thickness, resistance, penetration, surface, stiffness, moisture content, supplier.
- Ink: soiling margins of solvents, percentage of solvents, water absorption
- Dampening solution: additives and water quality
- Dryer and chill stand efficiency
- Use of a remoistening unit
- Silicone application
- Production possibilities: number of pages, type of fold, web width (1/1, 1/2, 1/4, etc.), inline finishing (gluing, stitching, trimming, perforation)
- Press settings
- Maintenance condition of the press and press crew skills
- Climatic conditions in the pressroom.

Adjustments: Adjustments during the print run can have a negative impact on quality.

Some folder settings have pre-adjustable components to help achieve quality, reduce waste and makeready time. Manual adjustments need more care.

Tolerances: Influencing factors:

- Folding aids (creasing, softening, perforating) help keep the folding tolerances tight
- Folding tolerances grow with the number of machine folds
- Inline stitched, or cross glued, products may need a reduction in press speed to keep tolerances
- Asymmetrical products significantly increase the folding tolerances in the quarter fold.

Performance specifications: Exceeding the folder-dependent performance specifications may lead to product damage and dog-ears.

Gussets: Occur along the intersection of the cross and quarter folds. These are due to the paper being stretched at the outside of the fold and compressed at the inside. This effect becomes more critical as the weight of paper increases and with the numbers of layers.

Perforation (cross and longitudinal): To minimise gussets different types of perforation are used depending on paper and bindery requirements. In general, thin papers have bigger gaps between the perforations to avoid the paper being ripped during further processing. Heavier papers have longer perforations because it is expected that the paper stability will still be sufficient to avoid paper ripping.



Perforated signatures are much flatter and are stacked more easily and accurately to facilitate offline binding.

Spine perforation: This is only possible if the product is to be perfect bound. For saddle stitching the spine must be undamaged. Higher paper weights can be more difficult to process and some production compromises may be needed, e.g. it may help to reduce production speed, to soften or crease the fold, and to reduce pressure of the folder rollers in the second longitudinal fold (quarter fold or chopper fold).



Changing perforation knives is time consuming and costly. It is recommended to group together print jobs with the same type of perforation.



Slim products may be critical for the shingle stream in the product delivery. A gap in the shingle stream can interrupt the complete bindery process because signatures cannot be re-stacked once there is a gap in the stream. To ensure that no gap emerges between the shingles, it may be necessary to reduce speed to maintain a small and constant distance between the single signatures.



Folding of high bulk paper should use only longitudinal folds (no cross fold) to avoid creases.



Production start-up: Lower quality papers (SC papers) with a rougher surface adhere more strongly to the angle bars at production start. Therefore, start production with a low air pressure at low speed; otherwise there is a risk that the ribbons may slip from their position, leading to paper jams and web breaks. Increase the air pressure when reaching higher print speed and production stability.



Electrostatics: The drying process creates electrostatic charging of the paper that helps keep ribbons in their correct position and avoid them slipping relative to each other. If the absolute paper humidity exceeds 6% then the paper loses this electrostatic adhesion.

Dedicated book production folders

The folder is the heart of high quality, consistency and productivity in book manufacturing for both printing and binding.

While closed head signatures are acceptable for magazine production of long grain products on coated paper, they are more limited for processing uncoated bulky papers used in book manufacturing.

Typically, conventional combination folders cut 2 times around the cylinder circumference, collect, then cross and then longitudinal fold to produce a closed head (quarto) fold. The result is often gusset wrinkles (crows feet) in the heads of the signatures; the bottom of the signature may swing out slightly and if it is subsequently sewn then the inner sheets will be pulled up tight offering the possibility to further introduce gusset wrinkle effects in the head of the copy.

The nature of folding with a closed head product creates potential issues for prepress to achieve good registration, issues on press with gussets, and a potential bindery issue if sewing is required.

Dedicated book production folders that eliminate closed head signatures by using a three sides open format are the key to production success:

- They eliminate the causes of poor quality folding, simplify pre-press, improve registration and eliminate any subsequent process issues
- This type of folder allows production using high bulk paper over wide web widths to maintain, or even increase, the number of pages per signature.
- More pages per signature improves efficiency through the entire process from prepress through to finished book. The result is fewer plates, less makereadies, and higher throughput from wider web widths.
- Postpress benefits from higher quality signatures for better feeding and improved bindery efficiency through less pockets on the gatherer section.

Book press folders with a 1260/1270 mm cylinder will cut the web in 4 around the circumference, then collect the four cut sheets prior to making a single long grain fold. This fold format requires no jaws or blades providing the operator with trouble free running because no additional head perforations are required. There is also less maintenance, downtime, and consumables than folders with traditional jaws and blades that are necessary for a closed head fold.

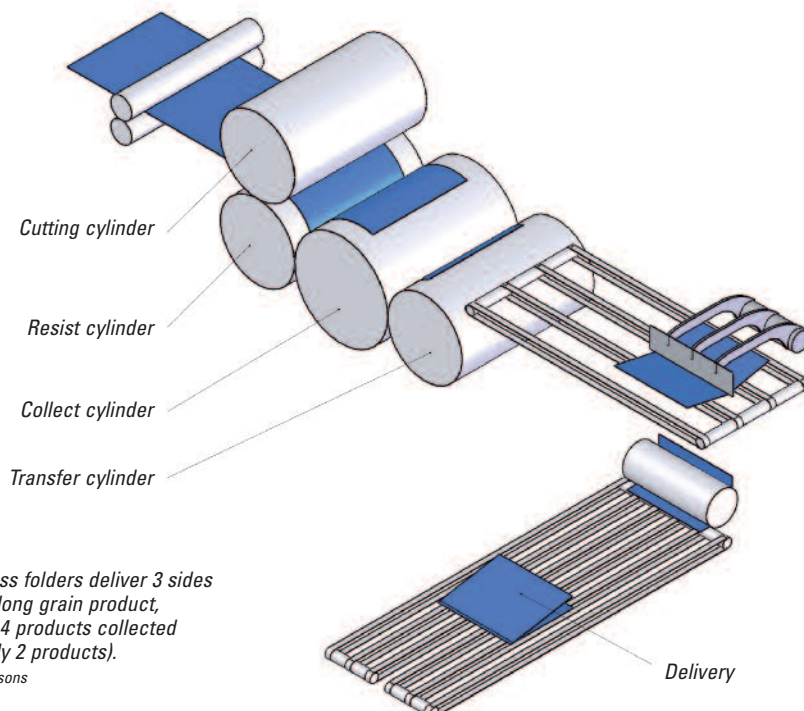

Book press folders deliver 3 sides open — long grain product, normally 4 products collected (optionally 2 products).

Source: Timsons

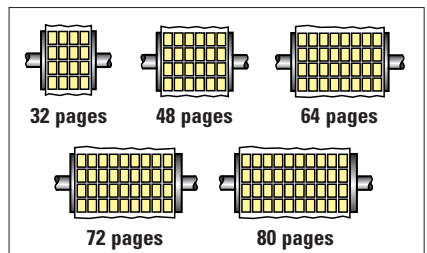

Long grain press format examples.

Source: manroland

Long grain: Paper fibre direction is parallel to A4 spine. The folder products are highly flexible for substrates and finishing possibilities. Most 16-page presses use this format and there has been a very strong increase of presses with bigger long grain formats. These are appropriate for book and magazine productions with given high page counts, they are also suitable for cost efficient insert production if the folder and its superstructure is capable to run lower page counts.

Grain direction: For presses the grain direction refers to A4 products.



Short grain press format examples.

Source: manroland

Short grain: Paper direction is at 90° to the spine direction (A4). Paper is not very flexible across its fibre direction; therefore, only lightweight papers can be used. It is helpful to have some remoistening device after the dryer to improve the paper's flexibility. Finishing possibilities are limited. Perfect binding with dispersion adhesive is not possible because when the glue is dry there are strong corrugations and gussets. It is also difficult to open the booklet as the corrugations stiffen the already stiff cross-fibre even more. Binding with hot melt adhesive is possible only if the drying process is controlled with care and a remoistening unit is used. Commercial short grain heatset presses provide increased productivity with higher web width. They have the correct fibre direction for A3 and A5 products. There are only a few presses of this type in the field.

Sheetfed covers & coatings

Printing process Coating	Wet offset + Inline WB coating	Wet offset + Primer + UV coating	UV Hybrid Inline UV coating	Classic UV no coating	Classic UV Inline UV coating
Printing applications					
Paper substrates	●●●●●	●●●●●	●●●●●	●●●●●	●●●●●
Plastic and foil substrates	●●	●●	●●	●●●	●●●●●
Scuff and scratch resistance	●●●	●●●●●	●●●●●	●●	●●●●●
Tactile and other surface effects	●●	●●	●●	–	●●
Overprinting varnishes and coatings	●●●	●●	●●	●●●●●	●●
Gloss quality	●●●	●●●●	●●●●●	●●	●●●●
Coating quality and ease of use	●●●●	●●●●	●●●●	–	●●●●

Comparative performance:
 Very good ●●●●●, Good ●●●●, Satisfactory ●●●, Fair ●●, Poor ●
 Source: Sun Chemical/PrintCity

The interactions between ink, coating and substrate along with the desired end-use characteristics determine the type of coating required – the type of press coating unit is an additional factor. There is no universal ink or coating for all substrates.

Neutral sealer: Gives functional protection to the printed surface to avoid marking in postpress processing and accelerated drying. It provides only a similar gloss to the substrate.

Conventional inks + WBC coating: Conventional offset inks and Water Based Coating (WBC) is a robust system and gloss is largely determined by the smoothness of the substrate.

UV inks without coating: Have similar total cost to conventional ink and coating but UV has higher resistance to marking, faster back-up and converting, no negative impact on the paper surface, and uses 50% less drying energy. Only a UV ink designed for this purpose can be used, usually with hard curing and an adapted slip package to prevent rub off and scuffing.

Conventional inks + primer + UV coating: An aqueous primer coating over conventional offset inks allows UV coating. A considerable amount of water is applied during primer coating and this must be removed by substrate absorption and accelerated evaporation prior to UV coating. Gloss is improved by using a fast drying primer. The properties of the substrate, ink film and coating thickness affect the gloss level. The coating layer only becomes stable several days after printing. Gloss withdrawal (dry back) is caused when oxidation drying of conventional inks and the primer continues under the cured UV coating, leading to differential gloss between printed and non-printed areas, less gloss and poor adhesion.

☞ Keep black Optical Density below 2.0 to reduce the risk, use a 40-50% screen of cyan under the black to minimise black film weight and dry back. This also has a positive effect of ink cure, flexibility and adhesion.

UV primer can be used to seal the surface of conventional ink jobs when differences in absorption appear: If the substrate absorption is very high there may be significant absorption of coating in non-printed areas with a corresponding loss of gloss. Different thicknesses of ink layers (and between ink layers) and the non-printed areas can lead to differences in absorption of the sealer and be responsible for differences in gloss (drawback). The volume of primer applied over conventional inks influences the final gloss level.

☞ Print with as little water as possible to minimise blanket ink build-up and reduce the risk of mottling.

☞ Use specially adapted inks to avoid risk of colour change when applying UV coating over conventional inks that contain non-solvent proof pigments (HKS 13, 25, 33, 43, PMS warm red, rhodamine red, purple, blue 072, reflex blue).

Classic UV inks + UV coatings: These produce the highest gloss. The gloss level is strongly related to the type of ink and the volume of coating. Fast-absorption inks should be used to maintain gloss at a good level. However, the risk of mottling restricts the latitude for absorption. The surface smoothness of cured UV coating is influenced by the content of wax and silicone derivatives (slip agents). These additives impair mechanical and temperature resistance, gluing, wetting and spreading. After curing, slip agents rise to the surface and show fingerprints when the surface is touched.

- Specify a UV coating with elastic properties suitable for binding, die-cutting and trimming to ensure good edges.

- Optimum gloss requires foam-free coatings to avoid spots on the finished surface. Use de-foaming agents.

Extract from PrintCity's "Optimised Sheetfed UV", the industry's only fully integrated generic best practice guide. The guide is available in five languages from participating companies — Eltosch, Böttcher, manroland, Merck, Sappi, Sun Chemical, Trelleborg and UPM — or from printcity.de.

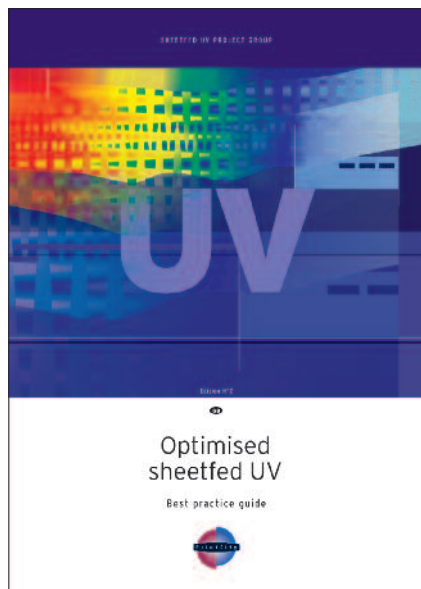

 Increasing the amount of UV coating applied can improve gloss level. Good coating flow becomes more difficult when applying high volumes. Heating the coating to 40°C (104°F) has a positive effect on flow properties and this can also increase gloss but on absorbent surface substrates can lead to a differential gloss, yellowing, poor cure and odour.

 The geometry of the anilox screen rollers strongly influences coating flow.

 Oxygen inhibition mainly occurs with low-viscosity UV coatings. It shows up after hardening in the form of a greasy film on the coating surface – when this film is wiped off, the coating surface below is glossy. The cause is high levels of oxygen that enter the coating and diffuse into its surface. The solution is high intensity curing to rapidly seal the ink surface to minimise oxygen entry.

Offline UV coating: Provided inks and coating are correctly selected for good inter-coat adhesion there is no need for a primer to be used when printing offline UV coating over dry UV inks. UV coating over dry conventional inks can lead to trapping difficulties. Lack of adhesion of the dried coating may result in orange peel effect or crater formation. Ensuring the right combination of materials throughout the production chain will avoid or minimise this risk.

- Too much spray powder reduces adhesion – use only the minimum quantity on an uncoated grade.
- Minimise excessive ink film weights and multi-colour builds that can cause excessive accumulation of ink distillates and additives at the ink surface during drying and which also reduces surface tension.
- Conventional inks must be completely dry prior to coating (minimum delay is about 48 hours).
- Avoid a long delay between printing and coating. After 72 hours, there is a risk of poor adhesion due to surface crystallisation and hardening with reduced surface tension.
- Apply the optimum coating film weight for maximum gloss and mechanical resistance.

Hybrid UV inks + Inline UV coating: The low UV-content ink system uses a single coater to apply UV coating, but this must be matched to the specific UV hybrid chemistry.

 Always test roller and blanket compounds prior to running non-classic UV. Provided correctly formulated hybrid UV inks are used, most blanket and roller problems are caused by incompatible washing agents or poor procedures.

 Ensure the ink supplier knows which inks will be wet-trapped to ensure that the tacks are correctly set. Special surface effects can be created using a mix of hybrid and conventional inks with UV coating.

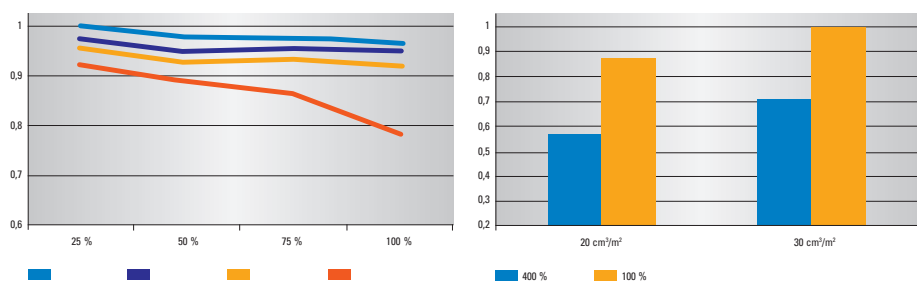



LEFT: When UV coating is applied over conventional oil-based inks the final gloss level is related to ink volume. RIGHT: UV gloss level over conventional inks and primers changes over time and it takes several days before hardening and drying is complete. Source: manroland

Coating application

Selection of the coating and its image carrier (blanket or photopolymer plate) depends upon the application: (1) Flood, the overall coating of a full sheet, (2) Knock-out of simple non-coated areas (glue flaps, book spines and ink-jet address panels) or (3) Spot coating to selected areas with precise registration. Gloss level is dependent on the substrate coating, ink coverage (the higher the ink film thickness and coverage, the lower the obtainable gloss), printing speed, the drying/curing system, coating method (and roller type), the coating substance, the temperature of the coating and the substrate. High gloss UV coatings require high carrying capacities for both flood or spot coating.

 Optimise the coating and film weight to the substrate for the best cost-to-gloss performance. Very thin substrates are more prone to cracking on sharp folds. Only apply the film weight necessary for maximum gloss and mechanical resistance. Keep the coating film weight as low as possible, typically < 3 gsm is OK. Exceeding this level gives little or no increase in gloss.

 Variations in the level of gloss are particularly noticeable on large flood coated areas; therefore, coating must be applied very evenly to ensure uniform gloss across the entire image.

 Ensure an even coating pressure between the roller and polymer plate. It is recommended to put continuous roller support strips (7mm/0,28" wide) along each outside edge of the plate.

 To optimise postpress operations use a flexible UV coating and ensure that tooling is correctly set as excessive pressure can affect the coating and substrate, leading to cracking.

 Beware that a high gloss coating over a dark solid area will easily show fingerprints.

Best postpress practices

Postpress systems

Efficient postpress systems are those designed for the specific production needs of inline or offline finishing taking into account the paginations, print runs and turnaround times required, plus other factors like workflow, waste disposal, back-up needs, and available space.

Efficient processes begin in the press delivery system that is the interface between the press and finishing. Web presses require fully automated systems to optimise processing. Every press delivery system is different and requires specialist advice for planning, installation and commissioning. Three important points must be taken into consideration: detailed planning of the overall concept, high level of production reliability, and the right level of automation.

Correctly stored printed signatures can improve offline binding productivity by 25-30%. Therefore, a high priority needs to be placed on optimising intermediate storage of signatures to ensure that the print products are reliably and efficiently processed. Roll, log, and bundle storage systems are each suited for different requirements.

Press Delivery Systems

Efficient processes begin in press delivery systems that are the interface between the press and finishing. The finishing department is often under pressure to minimise manning; however, the required manning level is actually determined by the type of intermediate signature storage system being used.

Intermediate signature storage

Correctly stored printed signatures can improve saddle stitching and perfect binding productivity by 25-30%. Therefore, a high priority needs to be placed on optimising intermediate storage of signatures because it is the only way to ensure that the print products are reliably and efficiently processed.

Three types of intermediate storage systems are available, each one suited to different requirements: roll and log storage are suitable for partially finished products; while stacks are used for press finished products as well as for intermediate storage. If the products are finished in-house, then a roll system provides the best performance and efficiency because of its large capacity and its loading independence. Logs are more suitable when a higher flexibility is required and are often used for external finishing.



Buffer system comparison

	Stacks	Logs	Rolls
Capacity LWC 54-56 gsm	480.000 pages/pallet	610.000 pages/pallet	500.000 pages/roll
Rotary press 60.000 copies/h 64 pages section	Manual: 4 persons Automatic palletizer: 1 person/3 palletizers	Semi-automatic: 1-2 persons/delivery Automatic palletizer: 1 person/3 log stackers	Rewind: 1 person/8 twin winding stations
Cycle time	< 5 sec/stack	< 1 min/log	8 min/Roll
Saddle Stitching/ Perfect Binding - Example: 8 feeders, 14.000 copies/h 32 pages/section	Manual 5-6 persons	from log 2 persons	from roll 1 lift truck driver/g 4-5 saddle stitching lines

The attributes of the three buffer storage systems available. Source: Muller Martini

Stacks for inline-finishing: Ensures that press finished products (that are glued or stitched directly in the printing press) can be simply and reliably prepared for distribution in the delivery systems. The products are fed at full press speed, cut on three sides in a rotary trimmer, and subsequently packed by compensating stackers and automatically palletised ready for distribution.

Logs for high net output: Integrated automation is essential for log formation. Systems with fast changeover times and automatic downloading of job specific parameters have a clear advantage to ensure perfect log formation. Horizontal log formation is preferable because the opening laps are not used to align the signatures and, therefore, cannot be damaged. Closed head signatures need a constant pressure during log building to ensure that the log retains its quality (no protruding signatures or banana shape). Excellent log quality is a prerequisite both to significantly reduce waste and increase net output in finishing.

Roll storage independent of time: Roll systems efficiently decouple printing from finishing and are the basis for the highest efficiency of the workflow within a printing plant. Their high level of automation is ideal for time independent feeding of high-speed saddle stitchers or for inserting machines in the mailroom.

Perfectly formed logs at high speed are created by horizontal formation. Photo: Muller Martini



Print roll systems

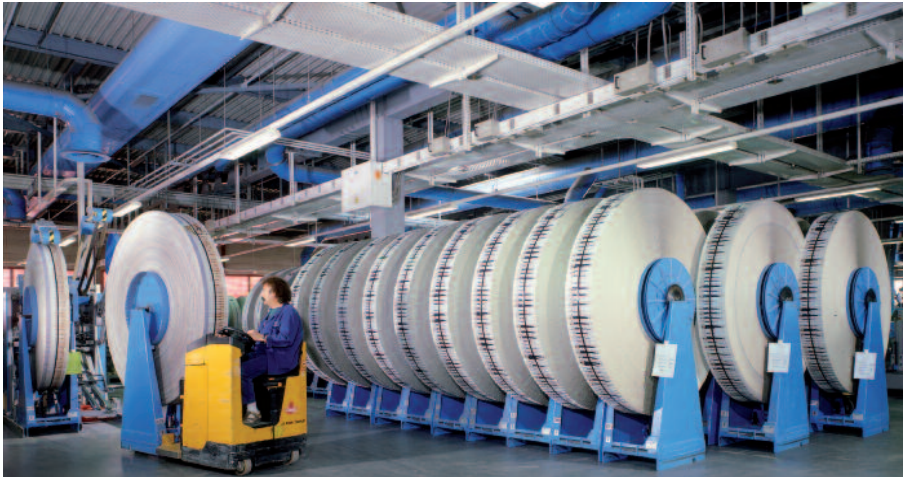

Precisely formed rolls that are well compressed and aligned on the roll are the prerequisite for reliable finishing.

 Marking can occur during wind-up around the tape and across the entire signature if the ink cannot withstand the rolling pressure. Poor roll alignment and marking occur if the tapes are not embedded in the shingle and their compression forces are not distributed across the entire signature — this leads to very high pressure in the tape area and with a tendency to move sideways and that will lead to a poor roll.

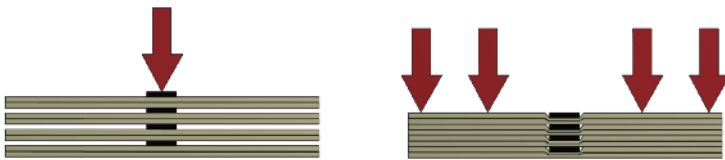



 Reduce the pressure to ensure that it is evenly distributed across the entire signature width.

- The belt should embed itself completely in the shingle so that the force is distributed across a wide surface to reduce localised belt pressure.
- If signatures are wound up in a thick shingle (8 –12 mm/0,31-0,47" pressed) there is less marking because the full rolls have fewer layers and this reduces internal pressure and belt tension.
- Improve the fold pressing of thick signatures before winding by using a pressing device. This also reduces faults during finishing.

Wrinkles: Can occur on signatures with a closed head or foot and these should be avoided by perforating at the fold to ensure the paper is stretched. A twin strap system can specifically back the head fold if used asymmetrically.

Overlap damage: Occurs if individual shingle layers are re-tensioned within the roll during rolling.

 Possible causes. Poorly pressed signatures with trapped air; strongly compressible paper stock; high gloss signatures; belt tension set too low.

 Solutions: Perforate the head or foot fold; install a pressing device upstream to press out the air; increase the belt tension.

Electrostatic charges: A high electrostatic level will reduce the unwinding speed. Thin shingles with a lower weight are more susceptible to static and release from the roll only with a slower unwinding speed than thicker and heavier shingles. Modern roller stands have a specially coated roll core to prevent static build-up to ensure easy unwinding of the last layer.

Belt breakage: Can be prevented by regular visual checks of the winding belts. The edges must be smooth and not have any tears in them.

Control & automation

Precise counting and tracking of the products in transit allow the press to be stopped at the exact good copy count to eliminate over-production waste. White paper and printed production waste can be tracked and ejected separately.

The importance of automation increases with the diversity of formatting options for the signatures, their run length and the frequency of changing print orders. Faster makeready and easier operation with reduced errors can be achieved using automated equipment connected to a JDF-compatible management information system (MIS). The electronic Job Definition Format contains all relevant data to pre-set and run the job — signatures to be processed, cutting length, run length, etc. Although the digital workflow does not eliminate all errors, it provides more security during set-up and when forwarding a job to the next machine. The integration of automated monitoring systems on the finishing line substantially reduces waste and improves process quality.



An overhead conveyor provides layout flexibility that is particularly important in narrow spaces and for linking up buildings or floors over long distances. Some systems can handle up to three shingle streams to transport a large number of copies per running meter at the lowest cost. Photo: Muller Martini Newsvevor

Logs

Logs are also known as bundles in the USA.

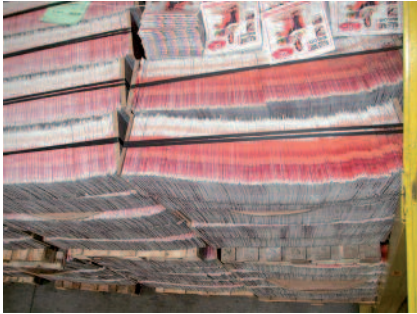

An example of poor log quality with misaligned signatures in a banana shape. Photo: Muller Martini

High quality logs have a significant impact on the productivity in the finishing department to ensure maximum speed, minimum waste, and interruption-free production.

- ⊘ Protruding signatures at the beginning and end of a log (poor log separation) will be damaged by the strap, leading to 6-10 wasted signatures per log.
- ⊘ Poorly aligned signatures within the log will lead to damaged overlaps that will cause frequent jams with increased waste.
- ⊘ Good logs have all signatures centred and evenly pressed.

Automated log formation, strapping and palletising can significantly improve productivity.

Log shape problems

- ⊘ Careless practices create unnecessary waste and increase production costs.
- ⊘ Best practice results are clearly visible and minimise waste and production costs.

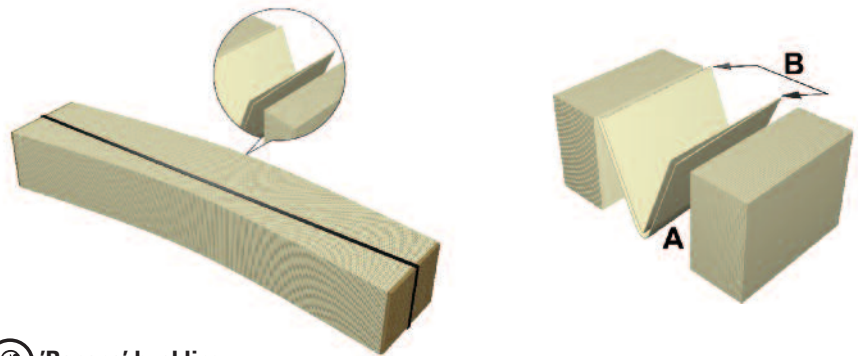

Log stability

- ⊘ The operational reliability of a finished log is reduced if the ratio of measurement A to B is extreme.
- ⊘ Solutions: Turn the log 90° in the log clamp before stacking it onto the wide side (B); or change the paper infeed direction so that the longer side is on the bottom.

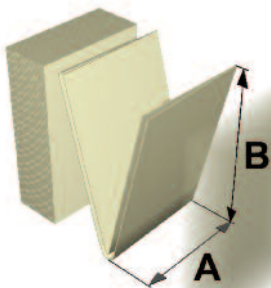

⊘ 'Banana' buckling

1. Thick paper = the thicker the paper, the more bulks the head fold B
2. Short spine A = the shorter the spine in relation to the head, the more risk of log buckling
3. Long logs = The longer the log, the greater the log buckling

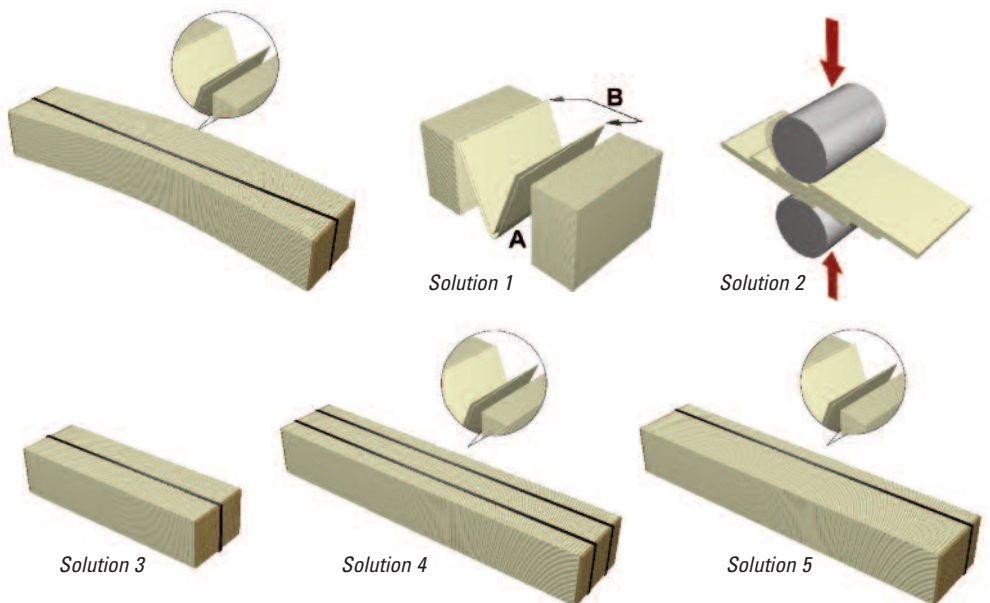

Solutions against 'banana' buckling: 1, Perforation on page B (head); 2, Shingle stream pressing; 3, Shorter logs; 4, Double strapping; 5, Asymmetric strapping. Source: Muller Martini

End boards

Avoid using end boards with sharp edges to reduce the risk of the strapping material breaking.

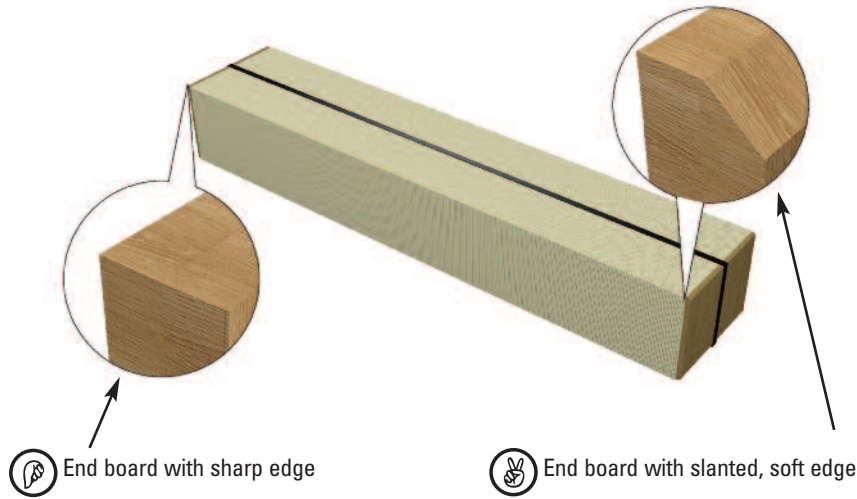

End board size

- End board that is too large
- End board that is too small

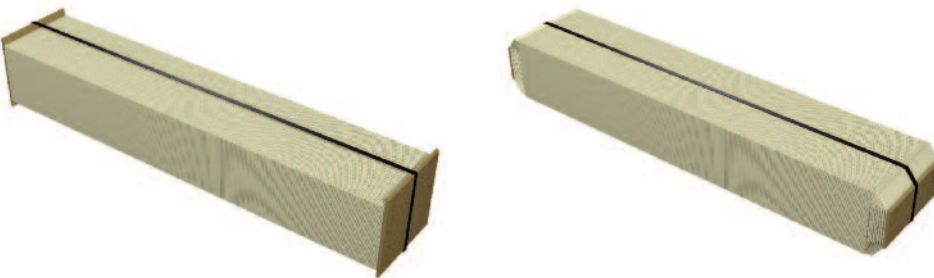

End boards that are too large make it impossible to create a stable loaded pallet. The strapping material may be damaged if the logs are stacked on top of one another, and logs risk falling apart. End boards that are too small lead to damage of the outer signatures by the strapping material.

The size of the end boards must be adapted to the size of the printed product to prevent damage to the printed product and strapping material – same size, not too big or too small. (Information about board size and quality can be obtained from the German Printing and Media Industries Federation.)

Strapping material: To prevent unstable pallets, the strapping material must conform to the supplier's specification sheets (maximum elongation and thickness, width ratio etc.). Quality is ensured if the linear expansion for the material is within the specified limits and the log remains stable. Logs will loosen and fall apart if the strapping is overstretched.

Inline stitched products are normally not suitable for log processing; however, this depends on thickness of the product (the thicker the better).

Wrinkles on the folded edge

Wrinkles on the inside of the spine and head are unwanted defects. The risk increases with thick paper combined with a high pagination as the paper can no longer give way.

Solutions:

- Strongly perforate the head fold to allow the paper to stretch and the air between the signatures to escape
- Reduce the number of pages (collect or double production)
- Use lighter paper



Incorrect pallet stacking can negatively impact signature quality, and can also be an accident risk. This photo shows the strap on logs in the lower pallet level are stretching which makes the second pallet from the right unstable.

Photo: Muller Martini

Inline rotary trimming

The quality of a trimmed product is affected by various factors with different impact levels. Quality is assessed in three areas:

1. Geometric trim quality
2. Trim surface characteristics
3. Trimming profile of cross section, concave, convex, slanted.

1: Geometric trim quality

Determining factors before trimming	Impact	
	High	Low
Geometric fold quality coming from the press folder	●	
Print products sticking to each other (moisture, static)	●	
Product stability (paper, page count, weight)	●	
Fold quality (bulky, slanted, perforated)		●
Fold vs printed image is slanted		●
General direction of shingle stream		●
Offset of individual products (quality of shingle stream)		●

Source: Muller Martini

Determining factors during trimming	Impact	
	High	Low
Production speed (too slow)	●	
Setting of the aligning unit	●	
Parallel setting of alignment unit in relation to transport belts	●	
Alignment and parallel setting of upper/lower and left/right transport belts	●	
Product support (particularly large size products and thin paper)	●	
Infeed angle of left and right transport belts		●
Pressure from upper to lower transport belts		●
Quality of transport belts		●

Source: Muller Martini

The geometric trim quality is normally measured in relation to the product spine and not to a printed reference because these may not necessarily have been printed parallel to the fold.



Check the quality of the fold before assessing the trim quality.

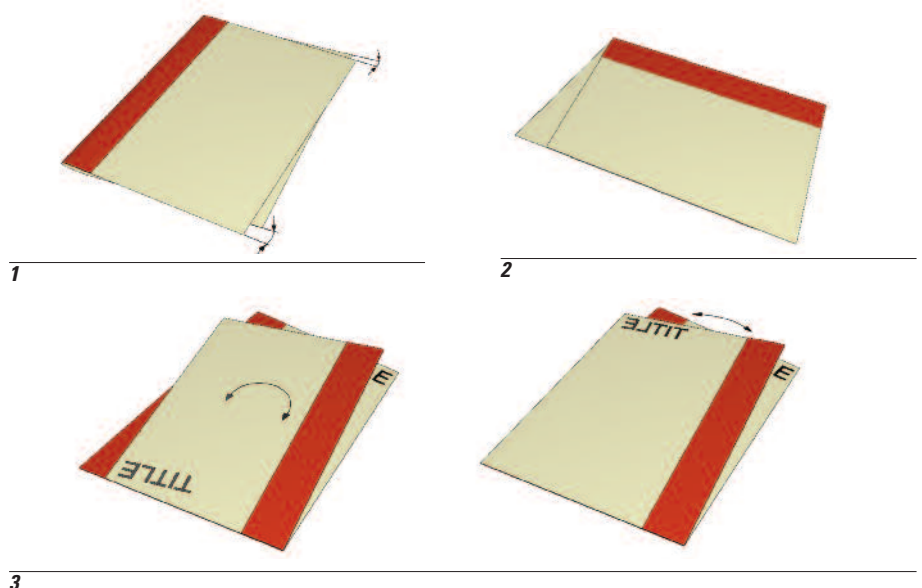

1- This example shows that an inaccurately folded product has a considerable impact on the geometric trim accuracy. Remember, a folding error on the spine duplicates itself on the head and foot page!

2- The cause of a trapezoidal trim is insufficient product support in the rotary trimmer.

3- The error can be tracked with a gauge or alternatively by (a) measuring individual products with a ruler on all four sides, (b) split a stack (about 6–20 products) and turn over one half to make any edge deviation visible after joining the halves together.

Source: Muller Martini

2: Trim surface characteristics

	Impact	
	High	Low
Product thickness (page count, paper weight)	●	
Shingle thickness	●	
Trim off below 3 mm (0,12")	●	
Trim sequence (head/foot before front)	●	
Strength of the vacuum system	●	
Knife quality (sharpness)	●	
Type of lower knife used (flat, pointed)	●	
Alignment of the of the knife elements	●	
Knife damages by trimming of stitches	●	
Grain direction	●	
Paper characteristics (silicon, clay content, UV varnishing)	●	
Production speed (too slow)		●

Source: Muller Martini

The surface characteristics are assessed by a visual check and are subjective. In principle, the rougher the cutting edge surface, the poorer the trim quality in terms of surface characteristics. Scores are best recognised in a stack of around five or more products and indicate a reduced trim quality, but they are hardly noticeable on individual products. It is also important to assess if the trim-off chip was possibly torn off by a too strong vacuum flow.

3: Trimming profile

	Impact	
	High	Low
Knife clearance too large	●	
High page count	●	
Alignment of the knife element (bevelled/concave cut)	●	
Pressure of transport belts	●	
Paper weight		●
Strength of exhaust/vacuum system		●

Source: Muller Martini

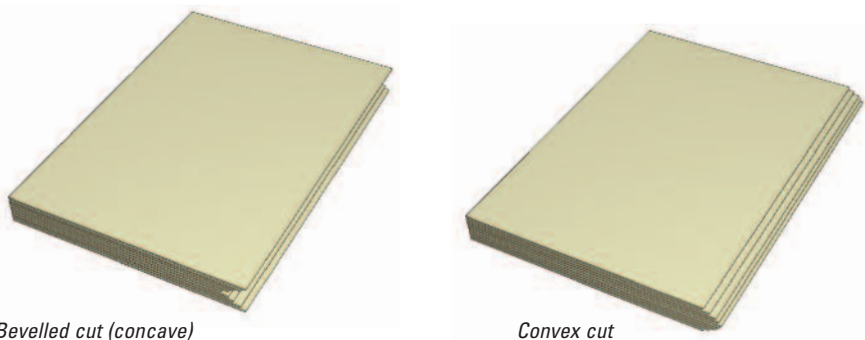

Bevelled cut (concave)

Convex cut

Diagonal cut

The fault cut can only be assessed visually and prevented by influencing the individual factors listed. Source: Muller Martini

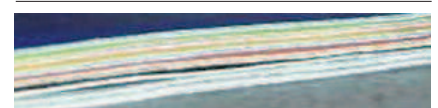

1

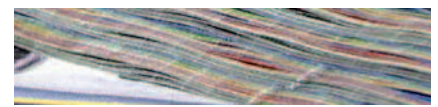

2

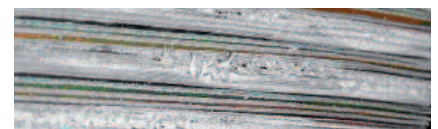

3

1- Good trim quality.

2- Acceptable trim quality (partly faulty or blunt blades).

3- Poor trim quality (trim-off below 3 mm (0,12") or vacuum too strong).

Photo: Muller Martini

Stack production

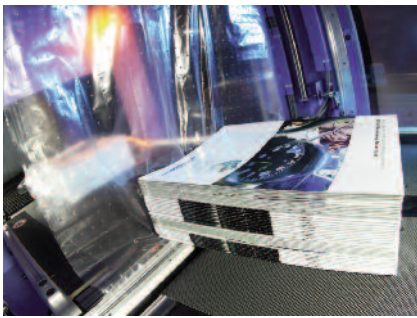

Perfect stack quality is the basis for reliable downstream automation. Photo: Muller Martini

Compensating stackers alternate the layer direction of a specific number of products to produce stable piles. Stack production can be used as a main process for finished products or as an intermediate storage solution. Important aspects for stack production are:

- Part or fully automated systems have a clear advantage in terms of production speed and production reliability. A high level of production reliability reduces production waste.
- Simple operation for the machine operator. Rapid and fine adjustment functions enable the operator to optimise the stack quality during production.
- The product has to be counted exactly to avoid over or under production.
- Only fault-free stack quality enables fully automated palletising.
- Layer pressing makes the stack more stable.
- The cycle time is influenced by the number of copies per layer and number of layers per stack.





Points to observe during processing:

- A regular shingle stream with well pressed printed products is the prerequisite for fault-free stack production.
- Avoid product damage by optimising the position and sizes of the stacker, adjusting the layer lift and pressing, use of electrostatic blocking for stack formation at infeed and/or delivery.
- Paper: different weight and types of paper require a change of stacker settings — follow the manufacturer's instructions.
- Signature size: modify the stacker (joggers, head stops, guides) when product dimensions change.
- Count: the signature thickness and flatness of the fold affect the number of signatures in a stack.
- Paper coating: different paper coatings require adapted belt speeds to achieve a correct shingle. Matt-coated paper tends to impede the process.
- Pressing device: the settings depend on the paper thickness and type. High gloss paper tends to tear and crinkle under high pressure, while LWC and uncoated paper frequently requires a stronger pressing. To minimise marking, reduce the pressure so that it is not visible.
- The pressure on a pressing device in the infeed must be set as high as possible. The folded edge bulks less to make the stack more stable.
- Ensure that the drying temperature minimises the risks of marking and blocking in the stacks.
- The product spine and head fold bulks more than the open sides. Depending on the thickness of the spine, the stack will become more stable with more layers.
- Stitched products bulk more in the spine. A good stack quality may need the reduction of stack height or the use of a pressing roller (best with grooves on the pressing roller at the stitch position)
- Stackers with layer lift allow for the production of individual layers. The result is a clean layer and a better stack quality. Ensure that the factory settings are retained on the separating device. Only change the settings in the event of marking and restore them to factory settings after production is complete.
- It is advisable to use the deforming device to stiffen signatures with a small page count, light paper, 3-page open signatures — to bring the individual signatures to the limit stop and thus produce a qualitatively better layer.
- Stacking of partial layers reduces the drop distance and improves stack quality. Partial layers can be individually pressed to build more stable stacks.
- A higher cycle time is needed when the stack is pushed straight-out as the stack requires a quarter turn more. This can interfere with the entire system's performance.

See page 23 to optimise packing and avoid transit damage.

Pallets & palletising

The condition and construction of the pallets is an important factor for correct temporary storage of logs or stacks of printed products.

-  Do not use disposable pallets because of their inadequate strength.
-  Avoid using pallets made of wood that is too fresh or too damp.

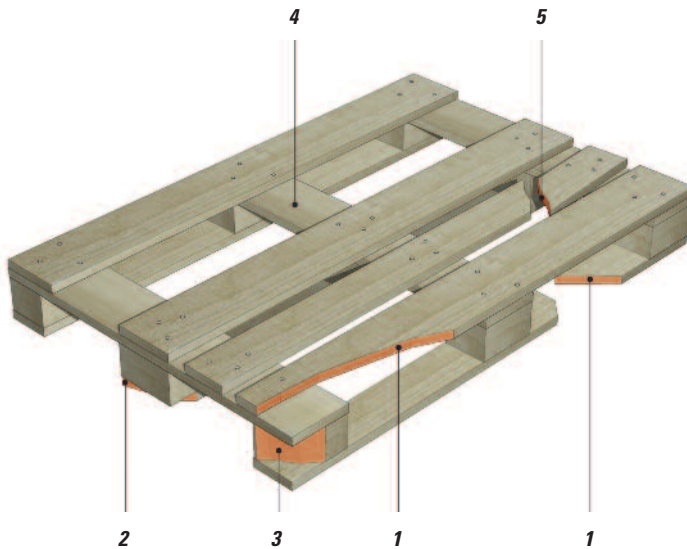



-  Avoid using wooden pallets with following damage: 1, an outer bottom or top board that is chipped on the corners or completely broken; 2, the central bottom board is broken or missing; 3, a block is missing or split; 4, a board is missing; 5, a board is broken; or if the load bearing capacity can no longer be guaranteed for other reasons. The faults described can be regarded as guidelines for replacement criteria for the pallets.
Plastic pallets — always check them for completeness and identify any cracks that can compromise the load bearing capacity.



*The consequence of using pallets in poor condition can be substantial damage to printed product and possible risk of accident.
Photo: Muller Martini*

Automatic palletising

-  Avoiding product damage by:
 - Place a cardboard sheet on to the pallet and in between the layers (prevents lasting deformations of the products) when palletising.
 - Use slip sheets that are not too thin and ensure that these are not too porous to prevent several slip sheets being drawn in.
 - Do not pile stacks or logs beyond the edge of the pallet.
 - Secure the pallets for external transportation with a wooden board on top and strapping to prevent marking caused by friction between the signatures.
-  Protecting products on pallets
 - Strapping improves stability.
 - Film wrapping protects the stacks or logs from dust and moisture.
 - Edge protection with strapping or film wrapping protects from damage.
-  Never store pallets on top of one another!



Correctly prepared logs are less subject to damage when palletised. Photo: Muller Martini

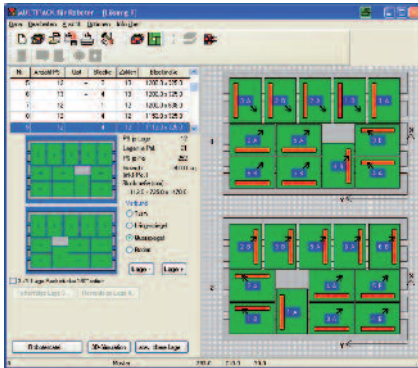

Gaps in the layers should be avoided, or planned to be as small as possible and above one another in the layers.

Stacks

- The higher side of the stacks should be positioned on the outside of the pallet.
- The stack spacing must be as small as possible to increase the stability of the loaded pallets. Film wrapped stacks must have a greater spacing of around 2-4 mm because of welded seam.
- A clean machine and the correct settings reduce wear and simplify the emergency aid in the event of a fault. The better the quality of stacks delivered from the stacker, the better the quality of the loaded pallet.



Logistics safety — attention that the permissible maximum weight is not exceeded.

Logs

- Depending on the loading method in the finishing stage, efficiency is increased by rotating the log in the press delivery by 180° before stacking off.
- Rotating the log 90° ensures that the overlap is not damaged by a log stacked on top and can increase the number of logs per pallet.
- The choice of pallet type is important. An Euro I pallet 1200x 800 mm (47,25x31,5") can be loaded lengthwise or crosswise and, depending of the signature size, this leads to a different utilisation of the pallet.

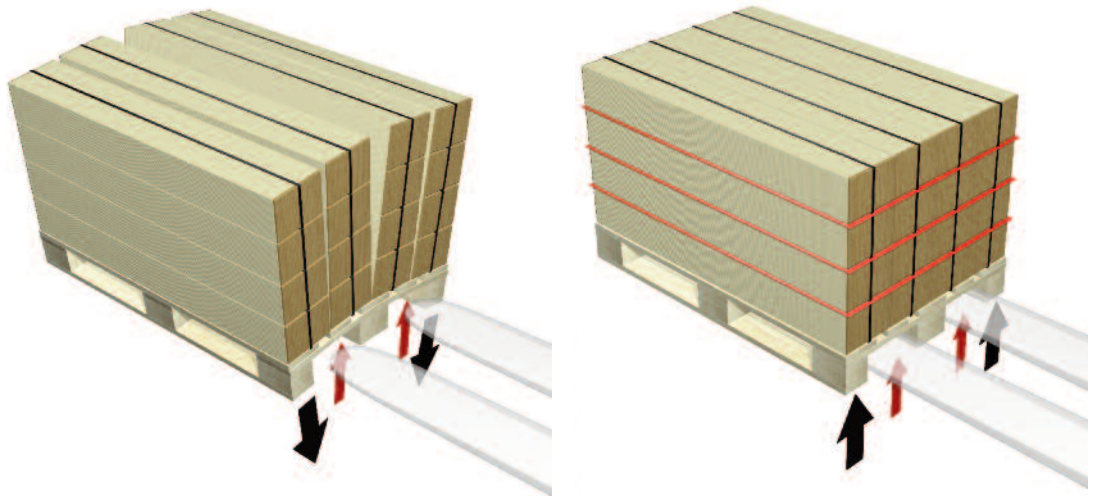

Log stability on pallets



Pallet bends due to the tension of the logs and the forklift truck.



Cardboard inserts improve stability during transportation. At least a slip sheet under the last layer.

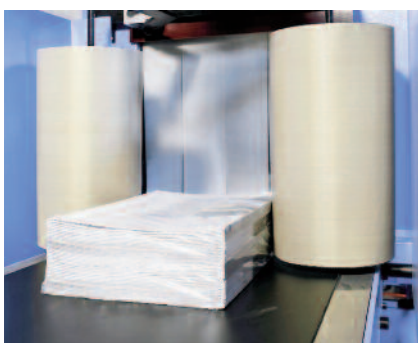

A stack after the shrink tunnel or a stack entering into the film wrapper. Source: Muller Martini

Prevent transit marking

The most frustrating and expensive waste comes after production from marking during shipping. While there is no definitive way to know which jobs will suffer transit marking, preventative steps can be made to minimise the risk of problems influenced by:

- How the job was printed (inks, coating, paper and drying)
- Packaging for transit
- Transit conditions and ambient factors including those during intermediate storage and at the destination.

There is some marking risk for all printed products but the highest risk is for books. Risk areas identified by “*Binding, Finishing & Mailing*” include:

Products with risk of marking

- Book covers on coated paper with medium to high ink coverage and without a protective coating.
- Heavy books with covers of coated paper that do not have a protective coating.
- Books with die-cut covers and/or inner cover pockets.
- Book covers with high ink coverage on the front and low coverage on the back cover (or vice versa).
- Certain inks, including metallic, reflecting blue, and several special shades of red are problematic.
- Matt coatings seem to have more risk than gloss.
- Critical ambient conditions at the plant, during transit or at destination. A high level of humidity can impede the drying process, while high temperatures can remoisten evaporating inks and coatings.

 Assess the risk. A simple first test is to rub the covers together with moderate pressure to see if ink flakes off or transfers to the opposing sheet. A more comprehensive method is to test bind and transit pack the job and place it in a jogger for an hour, or in the boot of car and driving it around for a while, then check for marking.

 Before starting to bind, check for damp ink by stroking your hand across the sheets to ensure that they are not sticky. Marking may still occur in spite of the ink having fully dried and/or if a protective coating has been applied.

 **Prevention:** Several important steps:

Covers: Protection using water-based or UV coating or plastic film lamination. A wide range of coatings is available (see page 12) and discuss with your supplier to ensure that the right coating is used.

Correct packaging box size: Products should lie close to each other with no damage to their corners. Put filling material into any gaps as loosely packed products slip around and smudge easily.

Slip sheet between each product: These absorb excessive friction and reduce the risk of marking considerably. Ensure that they are exactly the same size as the printed product. Slip sheets are effective although expensive.

Packaging for adhesive bound products: Pack books spine-to-spine. Separating the lifts with scrub resistant foam is better than a slip sheet, but is more expensive.

Shrink wrapping: Individually packed print products hardly ever smudge (as long as the cover has dried). However, this is expensive.

Pallet wrapping: It is important to secure cartons during shipment so that they do not move during shipment. Shrink wrapping bundles/cardboard boxes of products tightly on pallets provides good protection as it prevents items slipping during transit.

Stacks

Stacks can be electrostatically blocked, strapped or film wrapped to increase stability. This is particularly advisable for high gloss products, for long transport routes and long storage times.

 Electrostatic blocking is only effective for a limited amount of time dependent on ambient temperature, air humidity and vibrations. A safer solution is to implement blocking after stack production and a second blocking before entering the pallet dispenser.

 Film wrapping of stacks protects them against the weather and from mechanical damage. Choose the most suitable type and size of film and be aware of the film temperature and set machine accordingly.

 Damage to the strap (PP or PE strap) can be avoided by using wider straps and reducing strap tension to avoid tearing.

Drying and transit marking?

Heatset drying must evaporate all of the oil from the ink film. Most of the energy goes to heat the paper and the ink it is the last phase the evaporation of solvent and oils take place. Any ink oils/solvent retained in the paper coating (from incomplete solvent removal) can diffuse and attack the binder resins. This solvent can migrate and move to the surface to cause blocking where the bound copies will stick together. The ink film then becomes slightly tacky and is easily damaged from a minor scuffing motion.

Oil and water absorptivity is a method used to measure the interaction between the ink oils and the paper coatings. Papers categorised as ‘slow’ absorb and retain little or no ink oil, and require the least heat energy to prevent transit marking problems. Those categorised as ‘high’ require higher web exit temperatures to assure the removal of all the ink oil, water and solvent they can potentially absorb and retain. In the final drying phase, the web passes through chill rollers to cool it and allow the molten ink resins to solidify. If this cooling cycle is too rapid it allows a skin to form on the ink film surface, which can trap ink oil within the still soft ink film and/or the paper coating. An ink film that feels tack free and dry as it leaves the press can become slightly tacky over a short time. It cannot withstand the rigors of repeated rubbing and it is clear that residual oils in the ink, the coating or the packaging environment can lead to transit marking.

A slip sheet between the layers increases the stability of the pallet load. Photo: Muller Martini



Saddle stitching

Saddle stitching process steps

1. Loading/feeding: the products are fed from rolls, logs or stacks; the signatures are separated by vacuum, opened and then placed on the gathering chain.
2. Stitching: the gathered signatures are bound together with wire in the spine to form complete products and transported to the three-knife trimmer.
3. Cutting: the product is trimmed to the required final size.
4. Addressing: the product is labelled with the address on the outside.
5. Inserting/film wrapping: additional elements are automatically inserted or inserted to the product, which is then individual film wrapped.
6. Stacking: the finished products are compiled into the predefined stacks.
7. Packing: the individual stacks are film wrapped to protect them against shipping damages and weathering.
8. Palletising: the packaged stacks are piled down on pallets for further transportation and logistics.

Source: Muller Martini Primera E140

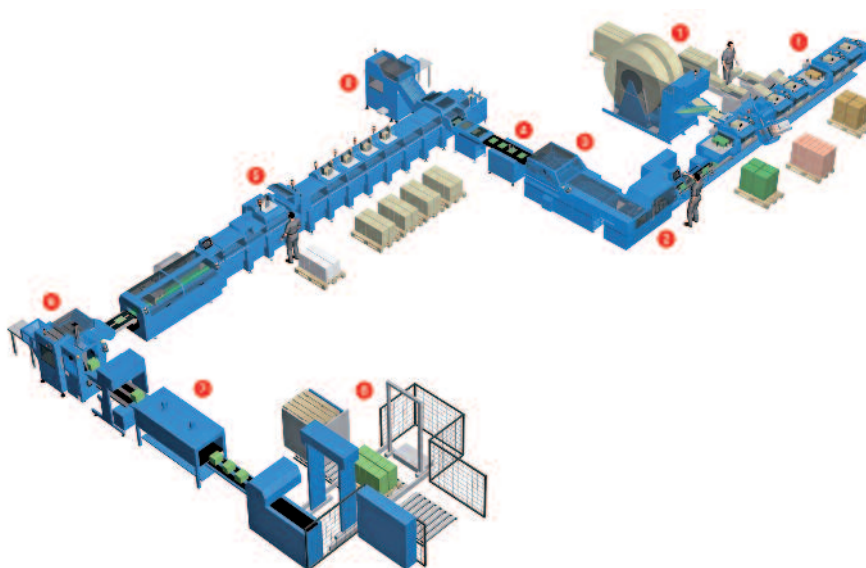

Different types of cover scoring.

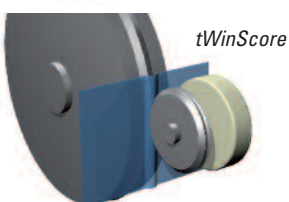
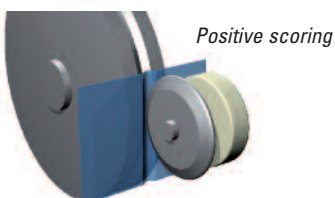

The tWinScore scoring wheel in the cover folder feeder produces excellent scoring quality. The scoring wheel has a W shape so that covers receive two perpendicular scores very close to each other. This ensures that the paper fibres are not damaged during scoring and do not break when folding. A sensing wheel ensures that the distance between the score and the drum remains the same, providing consistent scoring over the entire length of the cover. Settings can easily be made externally for all cover types and the option replaces both positive and negative scoring. A changeover is not necessary.

Source: Muller Martini

Signature types based on opening method

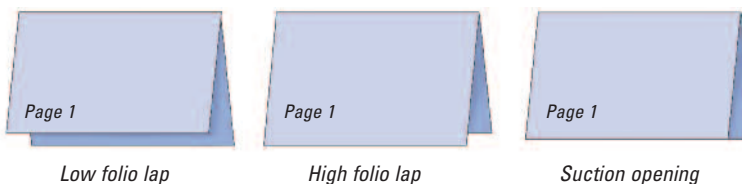

Signature types	Low folio lap	High folio lap	Suction opening
Frequency	The most frequently used (80%) opening type	Used very little, except for foot-operated lines or if an error happened in prepress	Different according to country and customer (20%)
Advantages	Increased output Quick set-up Processing reliability		Less paper used. Opening of inserts that are stitched in and are smaller than the jacket (e.g. poster)
Disadvantages	Increased use of paper	Increased use of paper	Longer set-up time Reduced performance of the machine

Cover

Factors that can lead to a cover being cracked include: thick paper; dark colours and heavy ink coverage; lamination; grain direction is not the same as the folding direction.

Grain direction: Cover and text paper grain direction should be parallel to the spine.

Register displacements: Single sheet covers that are not evenly cut can lead to register displacements. Multiple covers printed on a single sheet need to be correctly handled. It is important that after they are separated by a guillotine each separated lift is re-stacked in the same position on the pallet as they were before trimming and not mixed. The covers need to be fed from these separated lifts into the folder feeder.

Merchandise tipper

The merchandise tipper is designed for applying samples, cards, mini-leaflets, DVDs, CDs and sticky notes. It can be used at any feeder position in a saddle stitcher.



Sample application should ensure

- Gimmicks should be positioned evenly
- Optimum glue (opening time not too long)
- Correct glue temperature for optimum viscosity
- Sufficient pressing pressure
- Do not place samples in the middle as this allows to create clean stacks in the stacker or clean pallets in the palletiser
- Samples with liquid content — do not stack the pallets on top of each other.

Gathering

Individual signatures are gathered together by the feeders and transported on to the stitching machine in a continuous process. Errors that can occur include:

- Dog-eared corners during gathering from incorrect setting of air blast on gathering section (angle to surface of product — dependent on size); insufficient air blast; on fast running lines the dog-eared corners can be caused by the air flow; if this is the case then use electrostatic charging to block the signatures.
- Where images run across more than one page, ensure that the jogging of the signature on the chain is perfect. Set the correct timing of feeders and of air blast (choose optimum time at which signature arrives on the blade).

Stitching

The key to a successful product is in the quality of the stitching.



Correct staple Both legs too short Both legs too long Staple closed loosely Staple closed tightly



Driver worn out Stitching wire OK Stitching wire pressed flat Correctly preformed staple Leg too short

Wire quality must have sufficient strength, good bending properties and no resilience. Normally, wire thickness is 0,6 mm diameter (wire # 24) but can be as low as 0,34 mm diameter (# 30).

There are two different diameters for loop stitches available that have different effects:

- 8 mm (0,31") loop: the printed product is inserted in the file more easily, but it does not hang well. This is less of an issue if four loop heads are used.
- 6 mm (0,24") loop: the printed product is positioned nicely in a folder even with just two loop stitches. But the smaller loop is more delicate to hang the product in a folder.

Application check

A quality control check is necessary to ensure that merchandise samples and reply cards reach the recipient of the publication safely. An application check can identify if there is no adhesion when the merchandise samples are attached to the signature, and in this case inhibit the feeding of further signatures via the copy control.

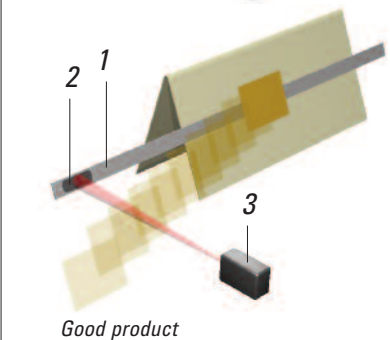
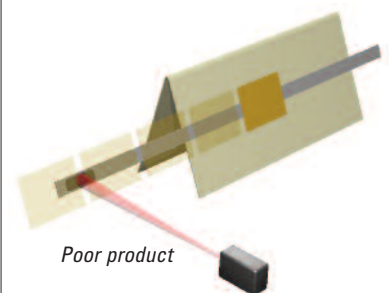

Principles of checking: The product to be applied is fed via a sword (1), at the end of which there is a reflector (2) aimed towards a photocell (3). Once the product has been correctly applied, the photocell sends a "Product good" signal via the control. If the product has not been glued on and falls to the ground in front of the photocell, the photocell does not send a signal. The control receives a "Product bad" signal and the product is rejected as incomplete. The check gives the bookbinder and the customer certainty that reply cards and merchandise samples were actually glued inside the printed product in the saddle stitcher and will reach the reader. Source: Muller Martini

Monitoring systems

Monitoring systems improve efficiency, binding quality and reliability. These focus on two areas: "product make-up" and "product quality". The make-up control focuses on missing sections and identification of each section to check if the product is complete. The feed monitor identifies if sections are missing, the blade monitor checks the feeding of signatures on the gathering chain. Each copy is checked against a reference value for lateral thickness measurement. Incomplete products are not stitched and are ejected before they reach the trimmer to reduce production waste.

Other checks for product quality include: barcode signature checking; oblique sheet and long book monitor to check the alignment of all sections on the chain; staple control checks if the staples correspond with the number entered ; trim monitor ensures that each product lies within the set tolerance for the required accuracy. Any products outside the range are ejected.

Connecting JDF-compatible saddle stitchers to a management information system (MIS) helps reduce makeready and sources of some errors. Statistical incident reports allow the causes of any interruption to be determined and resolved quickly.

Three-knife trimmer

The product is trimmed on three sides according to the pre-defined size

- Ink and dust deposits can make the conveyor belts of the trimmer dirty with a negative impact on product quality. This can be avoided by cleaning the conveyor belts regularly or by laminating the cover.
- Chips of paper that are not suctioned off and transported to the stacker can reach end users. A timed air blast, particularly on the front trim, solves this problem.
- Large, light products tend to be less stable and must be sufficiently supported in the trimmer to prevent a trapezoidal trim.

Trimming

Correctly sharpened and undamaged knives are crucial to the trim quality. The chamfer of knives must still be present, even after they have been ground several times, to ensure that they function correctly. Check knife and cutting quality.

Steel knife: The knife is sharp if it has a continuous sharpening thread along its whole length. Steel knives are less susceptible to nicks and are cheaper than carbide tipped knives but have a shorter service life.

Carbide tipped knife: The knife is sharp once it no longer has any nicks or shiny areas. The cutting quality can be reliably checked only with a microscope (min. 100x magnification) or on a surface tester with a special scanner. Carbide tipped knives last longer than steel knives but are more susceptible to nicks, e.g. cutting of staples (this can be avoided if long book control is present and activated).

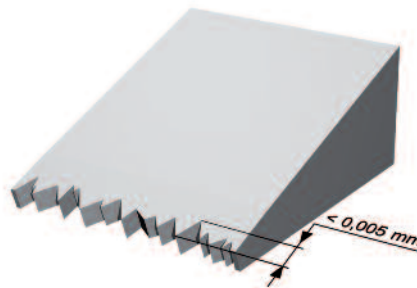

Nicks < 0.005 mm

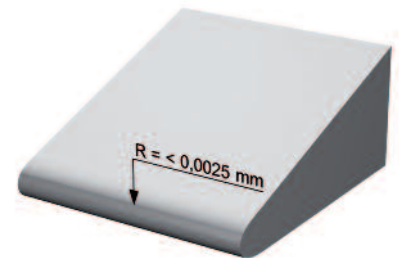

Dull edge = < 0.0025 mm

For optimum cutting, the nicks and blunting phase must be below the above values.

Two-up production: A rule of thumb is that the maximum product thickness is 2/3 of the trim out and this must be planned at prepress stage. The trim quality is reduced if this ratio is not observed.



Barcode reading is the most reliable product make-up check as a barcode label is read for each signature, and with the ASIR code the signature sequence can also be checked. Any signatures that do not match the scanned barcode or barcode/image section that has been accepted by the machine operator are ejected. Photo: Muller Martini

Minimise spine cracking

Some heatset products printed on LWC and SC papers have a risk of spine cracking in the fold, leading to saddle stitching problems. The centre pages of a publication become loose or fall out, or smaller splits around the stitches allow them to pull through. Any printing across the centre fold further increases the risk of cracking.



Best practices to reduce cracking

- If possible, run the centre section as a high-signature pagination.
- Ensure the dryer is set to the minimum paper temperature set point possible and the chill rollers are working efficiently. Excessive drying reduces the moisture of the paper making it more sensitive to cracking
- Use fold softening to remoisten the paper along the line of the spine; or use spine gluing so that centre pages are not held just by the stitches.
- Use an additive in the spine softening solution to reduce its surface tension so the water can more easily penetrate the paper.
- Ensure that folder nip rollers are not set too tight and are correctly adjusted with the same force at head and foot.
- Set chopper at correct right angle so it does not put an uneven pressure on the quarter fold.
- Ensure the caliper wheel in the saddle stitcher is not set too firmly as applying too much pressure to the centre fold may be a problem.
- Ensure that the wire knives in the stitching heads produce a clear cut and the staple legs are not overly bent. Staples must be of equal length. Use round stitches instead of flat.
- If the problem continues use glue on the middle section



Split along the line of the fold. Photo: SCA

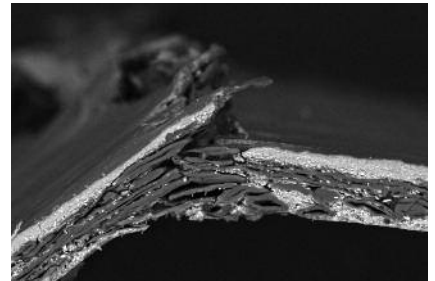

Microscopic cross section of paper cracking. Photo: SCA

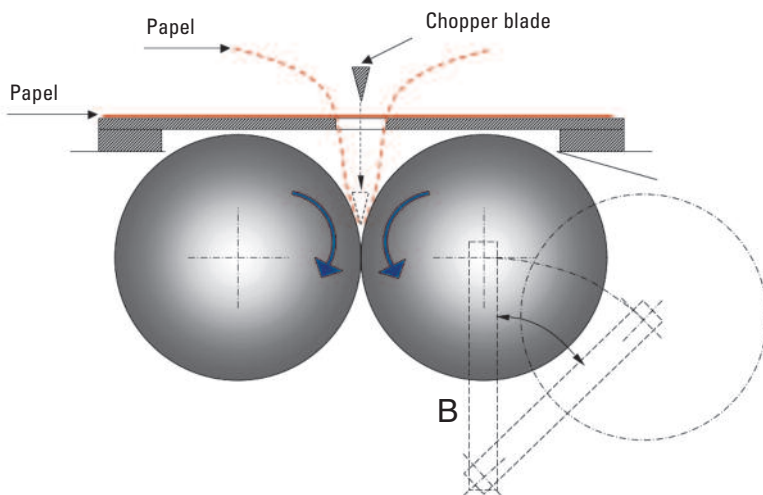

Typical set-up of nip roller mechanism, which makes the quarter fold (A4). Setting of the roller B determines how "tight" or "sharp" the final fold is.

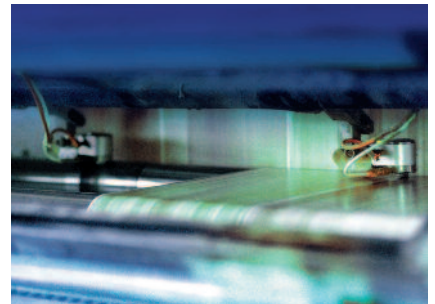

Use a back gluing on saddle stitched centre signatures with heavy ink coverage to minimise the risk of paper tearing around the stitching and the centre pages being pulled out.

Photo: Planatol

Perfect adhesive binding

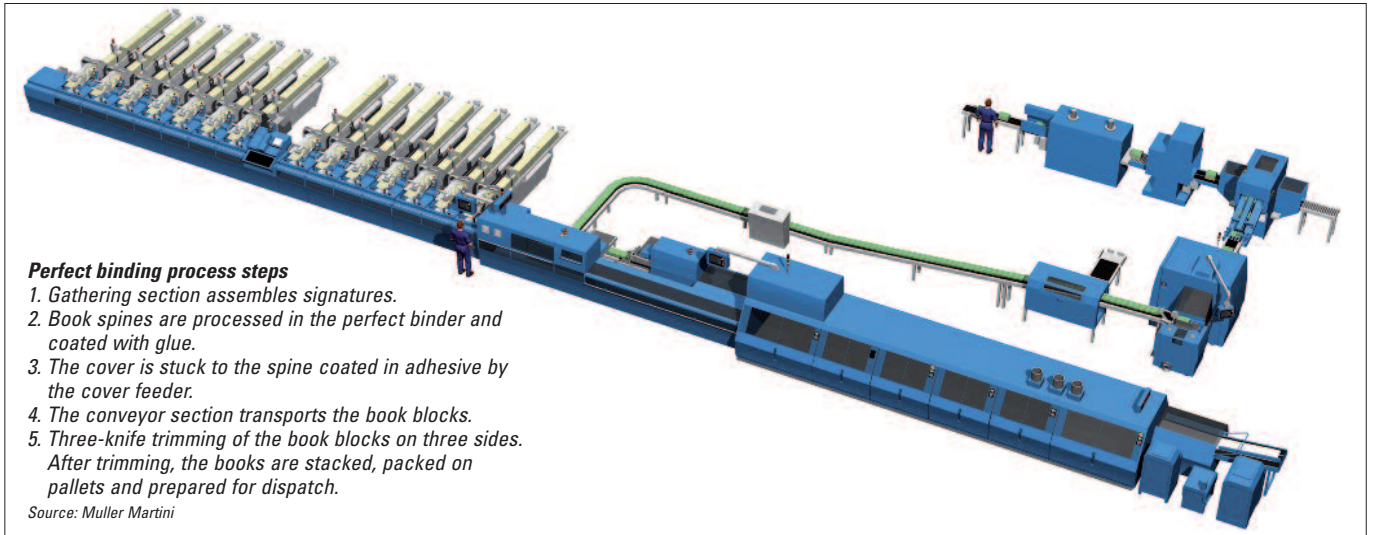

Perfect binding process steps

1. Gathering section assembles signatures.
2. Book spines are processed in the perfect binder and coated with glue.
3. The cover is stuck to the spine coated in adhesive by the cover feeder.
4. The conveyor section transports the book blocks.
5. Three-knife trimming of the book blocks on three sides.
After trimming, the books are stacked, packed on pallets and prepared for dispatch.

Source: Muller Martini

Perfect binding quality is determined by a range of paper characteristics: Fibre, filling materials, sizing, weight and thickness, grain and stretch, binding strength, tear resistance, and surface characteristics.

Paper types	Paper weight	Suitability
Gloss coated on both sides	< 90 gsm	Good
	< 115 gsm	Adequate
	> 115 gsm	Critical**
Matt coated on both sides	< 100 gsm	Good
	< 135 gsm	Adequate
	> 135 gsm	Critical**
Uncoated papers*	< 100 gsm	Very good
	< 135 gsm	Good
	> 135 gsm	Critical**
Recycled papers	100% recycled paper	Unsuitable
	Small proportion of recycled paper	Adequate
	Large proportion of recycled paper	Poor

A guide to suitability of different types of paper for perfect binding

*Higher weights are possible with uncoated surfaces and a porous paper structure.

**With weight over 135 gsm use PUR adhesive or thread sewing. Source: Muller Martini

Adhesive binding production success factors:

1. Select the correct raw materials – cover and text papers, inks, inserts
2. Select the packaging for post processing
3. Pilot series mock-up (check the shipping weight to prevent excess postage)
4. Confirm page layout, technical specifications, trims, bleeds etc. – a key dimension is the abrasive edge on the spine. The milling border on the spine can be 1–5 mm. It is particularly important for image gutters between adjacent pages, perforated inserts and gatefold covers.

Covers

Apart from weight and flexure rigidity, the bulk of the cardboard chosen for the cover plays a key role. These attributes must be modified to suit the format and block thickness. Products with too thick, or too stiff, covers are difficult to open and when opened the rear surface or the cover separate from the spine. Flexible covers aid the required mobility in the spine area. The following cover weights are guide values only as the flexure rigidity and bulk must also be considered:

Block thickness	Cover weight
< 5 mm (0,2")	150–180 gsm
6–10 mm (0,24-0,39")	200–220 gsm
11–15 mm (0,43-0,59")	250–270 gsm
> 15 mm (0,59")	300–350 gsm

Paper characteristics

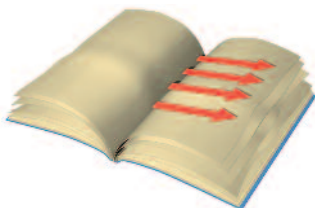

 Incorrect grain direction

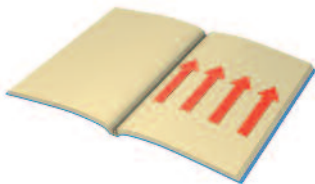

 Correct grain direction

The correct paper grain direction is essential for perfect binding.

Source: Muller Martini

These guidelines are particularly important for brochures with thin block thickness.

Correct layout of covers in adhesive binding is a key success factor:

- The grain direction must be parallel to the spine for a first-class hinge score on a die cutter.
- Covers over 200 gsm must use quadruple scored covers with side gluing.
- The spine length for the covers should be 3 mm (0,12") longer than the pre-processed format of the contents. Head plus 1 mm, foot plus 2 mm (0,079"), so that any escaping adhesive cannot contaminate the rubdown station. With double and multi-job production, the additional dimensions required for the intermediate cuts must also be taken into account for the covers.
- The cover area for spine gluing should be free of ink and coating or adhesion maybe impeded.
- The printed covers should be marked with feed and gripper edges.
- 3 mm (1/8") trim allowance for head and foot above and at the bottom of the signature trim. Always design books with identical trim margins for the head/foot trim. Always arrange the signatures in the same direction.

Printing on the spine: Avoid most spine printing problems by making a production mock-up using the paper specified for production. Remember that paper thickness varies between manufacturers, and even from the same manufacturer; varying levels of moisture can also have an effect on the thickness of a book. Where possible, leave clearance in the design, so that the bookbinder can make any corresponding adjustments.

Double cover effect: While perfect binders cannot apply double covers (as saddlestitchers do), it is possible to create this effect by adding a single sheet of the same paper and print quality as the cover on to the outside of the book block and then add the cover. This creates the look and feel of a double cover.

Adhesives

Two types of adhesive systems can be used in perfect binding: hot melt or cold glue. Each has its respective features and advantages. The criteria for selecting an adhesive include its suitability for the end-product use, the manufacturing process, the total cost, and the environmental impact. The main adhesives are:

- PVA (polyvinyl acetate) cold glue
- EVA (ethylene-vinyl acetate) hot melt
- PUR (polyurethane) reactive hot melt

	Adhesive type	PVA	EVA	PUR
Performance characteristics		Cold glue	Hot melt	Reactive hot melt
Curing time (unassisted drying) in hours		24-48	10-12	24-36
Curing strength		Good	Adequate	Excellent
Suitability for heavy weight papers		Average	Good	Excellent
Suitability for uncoated papers		Good	Good	Excellent
Suitability for coated papers		Poor	Good	Excellent
Suitability for UV coated & synthetic substrates		Poor	Poor	Excellent
Resistance to spine cracking at low temperature		Poor	Poor	Excellent
Resistance to spine cracking at high temperature		Poor	Poor	Excellent
Backbone (spine) flexibility		Good	Poor	Adequate
Resistance to aging deterioration		Good	Poor	Excellent
Susceptibility to nozzle blocking/contamination		No	Yes	Yes
Ease of production		Good	Moderate	Moderate
Ease of cleaning		Good	Moderate	Moderate
Relative adhesive cost		Moderate	Low	High

Relative characteristics of book gluing systems.

Source: "Binding, Finishing & Mailing" 2nd edition PIA 2005 and Muller Martini

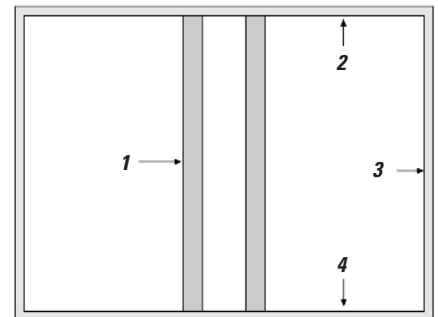

1- 6 mm (0,25") score (from spine edge)

2- 3 mm (0,125") head trim over and above signature trim

3- Ideally face and signature trims should be same size

4- 3 mm (0,125") foot trim over and above signature trim

Guidelines for the layout of covers in adhesive binding.

Source "Binding, Finishing and Mailing: The Final Word" PIA, 2005



Cold glue station. Photo: Muller Martini



Hot melt glue station. Photo: Muller Martini



PUR glue station. Photo: Muller Martini

Cold emulsion glue — PVA: Emulsion glues have been used since the 1930s. PVA is applied at room temperature and its resins penetrate the structure of the paper while drying to establish a solid bond. The glue hardens until it is semi-soft and forms a more flexible book spine than a hot melt. PVA is generally used in soft cover production because of its long drying time. It must be applied carefully and precisely to achieve good results. Typical products are diaries.

Advantages of emulsion glues —

- Intensive bond with the paper fibres
- Outstanding layflat characteristics
- High level of durability
- Good spine rounding characteristics
- Low glue consumption
- Low glue costs
- Good heat resistance
- No odours
- Wide resistant to mineral-oil printing ink.

Disadvantages of emulsion glues —

- Long drying time from natural drying process (no inline processing possible)
- High investment costs for inline processing with infrared drying/High frequency drying
- Paper becomes wavy if grain is in the wrong direction
- Sensitive to frost
- High energy costs for infrared and High frequency drying
- Poor flexibility in cold conditions (similar to hot melt); the glue film can break at +8°C (46°F).

Hot melt — EVA: Hot melts were introduced in the 1950s. They are water- and solvent-free adhesives that are a heterogeneous mixture of thermoplastics and additives such as resins, waxes, filling materials and stabilisers. A hot melt is in a solid state at room temperature. The liquid state for application requires heating to 120–180°C (248–356°F). The glue film is formed during cooling within a relatively short time. EVA based adhesives are generally used for book binding because they can be applied to coated and uncoated papers, have a high adhesive strength in most conditions, dry out very quickly, and are relatively inexpensive. Current EVA formulas are less susceptible to chemical corrosion as they age, tend to stiffen while cooling and can rip if stored in very cold conditions. Usage with heavily coated paper can be problematic.

Advantages of hot melts

- High production speeds
- Minimal waviness in paper with the grain in the wrong direction when using low temperature hot melts
- Relatively short cooling sections and times (1–2 minutes)
- Low operating requirements
- Ideal for short-lived products
- Cost effective for perfect binding.

Disadvantages of hot melts

- Low level of bond with the paper fibres
- Restricted layflat characteristics
- Poor durability
- Relatively high glue consumption (0.5 to 0.8 mm glue film)
- Higher glue costs compared to emulsion
- Reduced cold and heat resistance, very brittle below 10°C (50°F)
- Softens from around 40°C and pages can fall out from 60°C (140°F)
- Odour emission extraction necessary.

Reactive hot melt — PUR: Polyurethane glues have been used since 1990; they are regarded as the most flexible and durable adhesive for book binding. PUR is a single component reactive hot melt that hardens when exposed to air humidity. It is based on Duroplast, in contrast to conventional hot melts that are based on thermoplastics. The moisture reactive PUR hot melt is a good combination of the characteristics from traditional hot melts and reactive adhesive systems. The adhesive fusion occurs in special Melting on Demand (MOD) instruments with precise temperature control at 90–100°C (194–212°F) PUR is used increasingly for book binding due to its high strength, better durability, good temperature and solvent resistance. PUR is ideal for complex applications. It enables binding of paper with a low wood fibre content, UV coated signatures, or plastic laminated covers, and is even suitable for thickly coated heavy papers.

Advantages of reactive hot melt (PUR)

- Exceptional bond with the paper fibres
- Very high level of strength
- Acceptable layflat characteristics when used correctly
- Highest level of cold and heat resistance
- Best durability
- Resistant to mineral-oil based printing inks
- Less glue penetration for full-surface printed papers
- Minimum glue application (0.2 to 0.4 mm) depending on the application process
- Reduced risk of complaints.

Disadvantages of PUR reactive hot melt

- Higher glue costs
- Higher machine investment costs
- Longer curing time, limited possibility for inline processing
- Limited immediate assessment of binding quality
- Increased demands on the operating personnel
- Cleaning costs for glue station
- Intensive extraction of fumes required
- The perfect binder's spine preparation and clamp guides must be in good working order.

Adhesive environmental considerations

Recycling: Modern paper recycling plants use a flotation process that effectively treats glue contaminated paper (unlike older washing systems). Commonly used cold binding adhesives stay intact and can be screened out during recycling. Cold soluble adhesives dissolve into the pulp without problems providing their volume is not excessive. Hot melt adhesives should have a high melting point to allow better recycling by avoiding that they soften and squeeze through filters screens.

Use: Adhesive should be stored in sealed containers to prevent odours and dehydration of the product. Drip trays should also be placed under all dispensers to contain any spills. Hot melt emissions can be harmful to operators and systems should be installed to remove fumes.

Disposal: Non-soluble adhesive should be disposed of at a licensed disposal facility (not discharged to sewers). Water-based glues can be discharged to the sewerage system depending on local authority requirements.

For information on protective and cleaning measures for PUR in perfect binding see BPG 6 page 29.

Inadequate adhesive strength for the adhesive binding

Covers may not stick correctly to the book spine or detach themselves from the pages of the book if the ink or coating prevents correct glue adhesion. This occurs if no ink and coating free glue areas are allowed on the backbone and on the sides of the inner cover. Alternatively, ink solvents (particularly those with a high oil content) can dissolve the glue and reduce its adhesion.

Preparation: Create an ink and coating-free zone on the inner cover page, e.g. thickness of the book block plus 8-12 mm (0,31-0,47"), plus a 4-6 mm (0,16-0,24") wide side-gluing line.

Production: If it is not possible to create an ink and coating-free zone proceed as follows:

- Use a primer two-shot cold PVA glue system. First, apply a very thin layer of PVA primer, followed by the hot melt for the second run. This prevents any penetration by the second main layer of glue: or

- Use PUR glue in a single thin layer of 0,2-0,4 mm. PUR has outstanding pull value characteristics and is compatible with most types of materials used for covers or signatures.

Glue Penetration

Glue can penetrate the printed area of the book block if cold emulsified glue (PVA) is used on coated paper and also in thread sewn products, possible causes:

- Poor spine preparation due to using worn or inappropriately modified tools
- Signatures and book spines that were not correctly compressed before binding
- Pressure too high due to the applicator rollers on the book spine
- Cold glue with low viscosity penetrates the book block (increased surface tension and capillary effect on the printed area of coated types of paper).

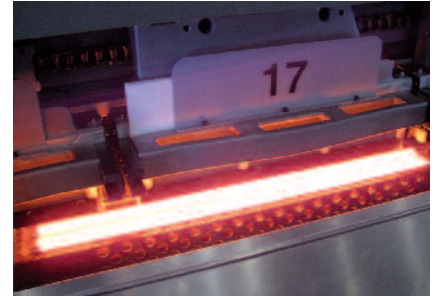

Infrared drying of PVA in perfect binder.

Photo: Muller Martini



Cold glue station with integrated glue bucket.

Photo: Muller Martini

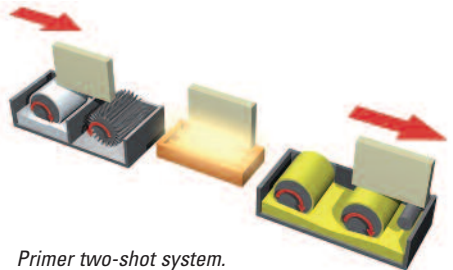

Primer two-shot system.

Source: Muller Martini



Interchangeable glue station in perfect binding line. Photo: Muller Martini

Test procedure for adhesives

Pull test

The most commonly used test procedure is where a single sheet is loosened from the glued film with a gradually increasing tension load or placed under tension until material failure. The load is constantly increased during the automatic test procedure. This has the same effect on the full length of the adhesive seam; therefore, the pull test is classed as a static test method. This method is always used to measure and record the strength of the adhesive bond between the sheet edges and the glue film.

The pull-out strength ascertained by the pull test is denoted as proof load in N/cm. The results in N/cm, in conjunction with the details about paper type, spine preparation technology, glue film strength, application temperature, production speed, etc., provide meaningful comparative figures independent of the book format.

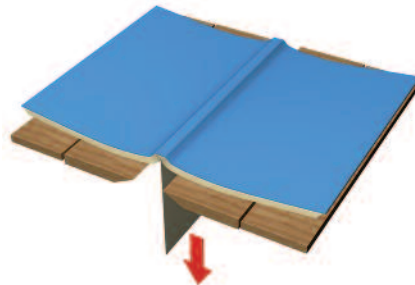

In the pull test, the test sheet is pulled out of the adhesive film via a continually increasing tension load.

Source: Muller Martini

Evaluating pull test data

FOGRA recommends making five tests across the entire book block to determine its binding quality. The resulting mean average is then divided by the format length in cm and the results recorded in a test protocol (in which all other relevant data is recorded). The torn out sheets and the processed sheet edges must be considered when assessing the results, as these often provide valuable explanations.

The quality guidelines drawn up by FOGRA for glue bound products have become widely accepted in Europe. Different guide values are used for emulsion and polyurethane than for hot melt. The USA and UK use different quality scales.

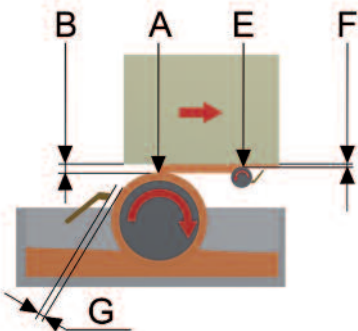

PUR glue system applicator roller: A, applicator roller; B, spacing of applicator roller to book spine; E, levelling roller (spinner); F, glue film strength after levelling 0.3-0.5 mm. G, doctor blade opening. Source: Muller Martini

FOGRA Quality Levels

Hot melt	Quality level	Emulsion and PUR	Quality level
Up to 4.5 N/cm	Poor durability	Up to 5.5 N/cm	Poor durability
4.5 - 6.2 N/cm	Adequate durability	5.5 - 6.5 N/cm	Adequate durability
6.2 - 7.2 N/cm	Good durability	6.5 - 7.5 N/cm	Good durability
More than 7.2 N/cm	Very good durability	More than 7.5 N/cm	Very good durability

UK Quality Levels

All adhesives	Quality level	USA Quality Levels	Quality level
Up to 5.0 N/cm	Poor durability	Up to 2.00 lb/in	Poor durability
5.0 - 7.25 N/cm	Adequate durability	2.00 - 2.5 lb/in	Adequate durability
7.25 - 9 N/cm	Good durability	2.5 - 3.5 lb/in	Good durability
More than 9 N/cm	Very good durability	3.5 - 4.00 lb/in	Very good durability
		More than 4.00 lb/in	Outstanding durability

1 N (Newton) = 0.1 kp 1 lb/in = 1.8 N/cm

Other testing methods include: flex test (sheet turning test), layflat test, diagonal pull test, subway test.

Adhesive Binding Systems

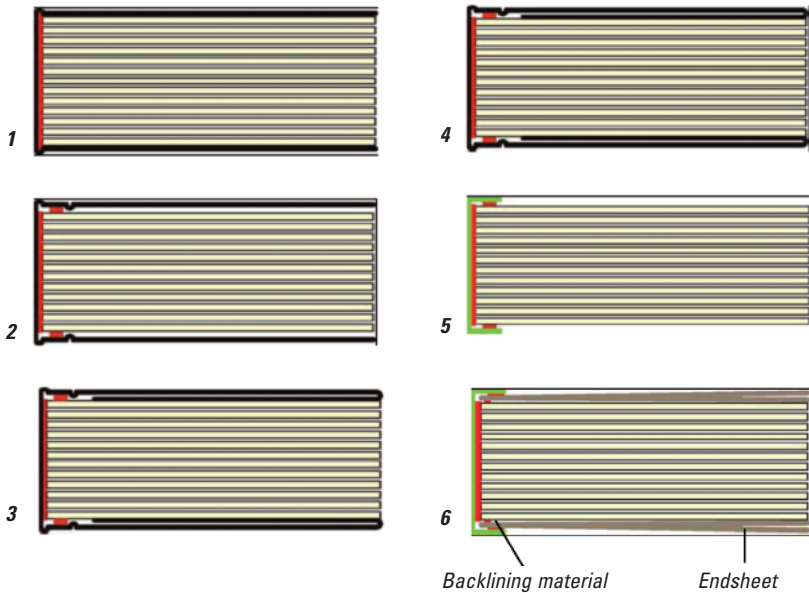

There are a range of options to achieve complete adhesion between the book block spine and its cover:

- 1- Book with double scored cover, without side gluing. The cover only sticks to the book spine. Adhesive binding possible with PVA, hot melt or PUR.
- 2- Book with side gluing and quadruple scored cover. The cover not only sticks to the book spine but also to the front and back.
- 3- Brochure with side gluing, quadruple scored cover and folded in flaps. The flaps do not reach the book block. Can be manufactured in one run.
- 4- Flaps protruding or flush. Two runs or special trimmer required.
- 5- Book block with side gluing and back lining material overlapping on the sides.
- 6- Book block with side gluing and endsheets. Endsheets fed and glued inline, with back lining material overlapping on the sides.

Book block with side gluing and combined endsheets. There are two versions:

- The combined end sheets are produced offline on special endsheet combiners
- The combined end sheets with overlapping back lining material are fed via the cover feeder.

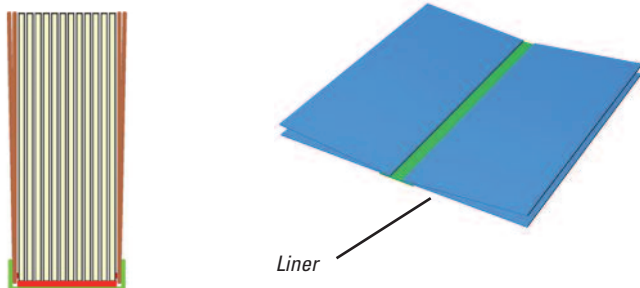

Single sided adhesion between book block and cover

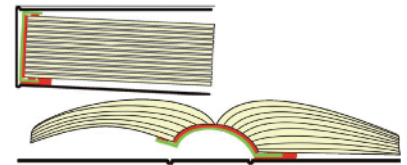

The Swiss brochure binding system is a book block mounted in the third cover page with a precisely lined spine. This elegant type of book is mainly used for thinner, demanding publications. It usually has a rigid cover. This cover can be trimmed smooth on three sides and has protruding edges or a folded-in front flap.

Layflat books glued with one or several layers, with space between the book block spine and cover

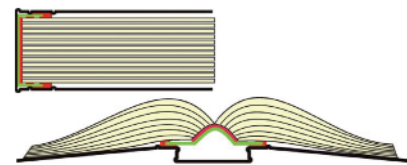

The Otabind binding system has the book block connected linearly to the sides of the second and third cover. The lined spine remains hollow meaning that a clamping effect cannot occur. From a functional perspective, the book block has a layflat opening. That is why this binding system is predominantly used for school and scholarly books as well as operating manuals.

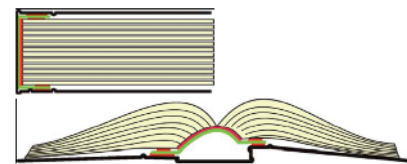

Swiss binding system (also called Eurobinding) is similar to the Otabind. The only difference is that the cover is scored five times rather than six. This enables a single-sided hinge effect on the back page. The cover is glued to the second page between the first and second score and on the third cover page between the fourth and fifth score.

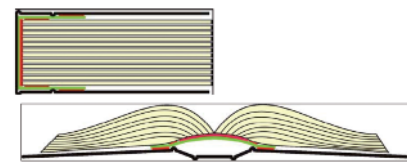

RepKover is a registered trademark associated with Otabind. The RepKover binding system is best known in the USA. It is predominantly used for smaller print runs. The covers are provided with a liner stripe offline. This can be performed on simple instruments or on a special spine-gluing machine. To guarantee layflat opening, PVA or PUR is to be used.

Aylesford Newsprint

Aylesford Newsprint is a dedicated manufacturer of premium quality newsprint. Its "Renaissance" brand is widely used by many major European newspaper publishers. The mill specialises in 100% recycled newsprint of exceptional runability and superior printability — brighter, cleaner and with high opacity. All products are made exclusively by recycled paper using highly skilled staff operating the most advanced technology available. The company's continuous improvement programme helps ensure the attainment of the highest operational and environmental standards. Aylesford Newsprint is jointly owned by SCA Forest Products and Mondi Europe who bring a wealth of experience in quality paper manufacture. www.aylesford-newsprint.co.uk

Kodak

Kodak GCG (Graphics Communications Group) is a unit of Eastman Kodak Company, the world's foremost imaging innovator. The Graphic Communications Group provides commercial printers, packaging printers, publishers, data printers, and enterprises with one of the broadest portfolios of technologies, products, and services in the graphic communications and document capture industries. With headquarters in Rochester, NY, USA, the company serves customers around the globe with regional offices in the United States, Europe, Japan, Asia Pacific and Latin America. www.kodak.com

manroland

manroland AG is one of the leading printing systems manufacturer and the global market leader in web offset. Webfed and sheetfed offset presses from Augsburg and Offenbach provide tailor-made solutions for publishing, commercial, and packaging printing. A worldwide network of around 100 sales and service centers markets manroland's own products and inkjet-based digital printing systems from Océ as well as ancillary printing equipment and pressroom products. www.manroland.com



MEGTEC Systems is the world's largest supplier of webline and environmental technologies for web offset printing. The company is a specialised system supplier for roll and web handling (loading systems, pasters, infeeds) and web drying and conditioning (hot air dryers, oxidizers, chill rolls). MEGTEC combines these technologies with in-depth process knowledge and experience in coldset and heatset printing. MEGTEC has manufacturing and R&D facilities in the US, France, Sweden and Germany, China and India along with regional sales, service and parts centres. MEGTEC also provides energy and efficiency consulting and machine upgrades. www.megtec.com

MÜLLER MARTINI

Müller Martini is a globally active Swiss-based group of companies who are leaders in the development, manufacture and marketing of a broad range of print finishing systems. Since its foundation in 1946, the family owned business has created innovative products exclusively tailored to the demanding needs of the graphic arts industry. Today, the company has seven business sectors: Web offset printing presses; Press delivery (conveying, trimming, bundle and log forming, palletising, roll systems); Saddle stitching systems (saddle stitching, inserting, packaging); Soft cover production (perfect binding); Hard cover production; Newspaper mailroom systems; Digital solutions (industry first solution networking all digital processing components). www.mullermartini.com

NITTO DENKO

Nitto Denko Corporation is one of the world's specialist suppliers of polymer processing and precision coating. The company was formed in Japan in 1918 and employs 12 000 people all over the world. Nitto Europe NV is a subsidiary, which was founded in 1974 and is the group's leading supplier to the paper and printing industries with products like repulpable double-coated adhesive tapes for splicing systems. Nitto has also become the reference supplier to offset and gravure printers worldwide. Nitto Europe NV is ISO 9001 certified. www.nittoeurope.com, www.permacel.com, www.nitto.co.jp

QuadTech is a worldwide leader in the design and manufacture of control systems that help commercial, newspaper, publication and packaging printers improve their performance, productivity and bottom line results. The company offers an extensive range of auxiliary controls, including its best-selling register guidance systems (RGS), the award-winning Color Control System (CCS) and the widely-known Autotron. QuadTech, founded in 1979, is a subsidiary of Quad/Graphics and is based in Wisconsin, USA. The company was ISO 9001 registered in 2001. www.quadtechworld.com

QuadTech.

SCA (Svenska Cellulosa Aktiebolaget) is a global hygiene and paper company that develops and produces personal care products, tissue, packaging solutions, publication papers and solid wood products. Sales are conducted in 100 countries. SCA has annual sales in excess of SEK 109 billion (c. € 11,5 billion) and production facilities in more than 40 countries. SCA had approximately 45 000 employees at the beginning of 2007. SCA has a range of high grade, customised publication papers for newspapers, supplements, magazines, catalogues and commercial printing. www.sca.com, www.publicationpapers.sca.com



Sun Chemical, the world's largest producer of printing inks and pigments, is a leading provider of materials to packaging, publication, coatings, plastics, cosmetics, and other industrial markets. With annual sales over \$4 billion, Sun Chemical has more than 11 000 employees supporting customers around the world. The Sun Chemical Group of companies includes such established names as Coates, Hartmann, Kohl & Madden, and US Ink. Sun Chemical Corporation is a subsidiary of Sun Chemical Group B.V., the Netherlands, and is headquartered in Parsippany, New Jersey, USA. www.sunchemical.com



Trelleborg Printing Blankets is a product area within Trelleborg Coated Systems. The Trelleborg Group is a world industrial leader in advanced polymer technology for high performance solutions to seal, damp and protect in demanding environments. Over 50 years' printing industry experience - more than any other blanket producer - is combined with innovative technology, patented processes, vertical integration and total quality management. Servicing 60 countries on five continents, Rollin® (formerly MacDermid Printing Blankets) and Vulcan® are brand leaders, providing offset printing blankets for the web, sheet-fed, newspaper, business forms, metal decorating and packaging markets. www.trelleborg.com/printing



Project associates

Eltex Elektrostatik GmbH is the world's leading manufacturer of electrostatic systems for industry. Founded in 1953 in Weil am Rhein, Germany, the company's intelligent solutions have established themselves in numerous industrial sectors – first and foremost in printing and print finishing, as well as in the plastics industry. Eltex discharge and charging systems prove their worth in a vast array of applications and set the standards throughout all industrial sectors. A global presence is provided by an international sales network of 45 agents. www.eltex.com



Timsons is a family owned company founded in 1896 specialising in the design and manufacture of rotary printing presses for nearly 100 years. Today, the name Timsons is synonymous with book printing, enjoying a worldwide reputation for both dynamic innovation and quality engineering. Offering each of our customers a tailor made solution that will provide the tools to be market leaders in their chosen fields. Whether this is ultra thin bible papers, bulky book papers or high grammage coated papers a Timson press can run them all. Timsons has embraced the digital world providing a wide range of options for postpress, inline or near line, web based finishing systems. This draws upon our extensive knowledge and experience of handling a wide range of paper types. www.timsons.com





www.wocg.info **e-TOOLBOX**

Members

www.kodak.com

www.man-roland.com

www.megtec.com

www.mullermartini.com

www.nittoeurope.com, www.permacel.com, www.nitto.co.jp

www.quadtechworld.com

www.sca.com, www.publicationpapers.sca.com

www.sunchemical.com, www.dic.co.jp

www.trelleborg.com

In association with